

INDUSTRIAL TOOLS





Mastering power

Holmatro products are all about the principle that only controlled power can be deployed effectively. We have expressed this vision in the slogan 'Mastering Power'. Still, for over 50 years after the foundation in 1967, we keep honoring our traditional Dutch roots and represent innovation, quality and support. That is why we design, develop, manufacture, and test our tools in-house. Our experience with high-pressure hydraulics enables us to seek out the boundaries of what is technically possible. This has made our tools lighter, compact, more durable, and easier to use.

holmatro.com

TABLE OF CONTENTS

INTRODUCTION

- 6 About Holmatro
- 8 Basic knowledge of hydraulics

HYDRAULIC CYLINDERS

- 12 Composing a hydraulic cylinder system
- 13 Holmatro cylinders
- 14 Selection list cylinders
- 17 Selection list hollow plunger cylinders
- 18 Aluminium cylinders | spring return
- 20 Aluminium cylinders | hydraulic return
- 23 Short stroke cylinders | spring return
- 24 Flat cylinders | spring return
- 26 Multi purpose cylinders | spring return
- 30 Multi purpose cylinders | set
- 31 Multi purpose cylinders | set parts
- 34 Telescopic cylinders | gravity return
- 35 Locknut cylinders | gravity return
- 36 Locknut cylinders | hydraulic return
- 38 High tonnage cylinders | gravity return
- 40 High tonnage cylinders | hydraulic return
- 42 Construction cylinders | hydraulic return
- 43 Hollow plunger cylinders | gravity return
- 44 Hollow plunger cylinders | spring return
- 46 Hollow plunger cylinders | hydraulic return
- 47 Pulling cylinders | spring return
- 48 Pulling cylinders | hydraulic return
- 49 Pulling cylinders | pulling eyes
- 49 Pulling cylinders | clevis eyes
- 49 Pulling cylinders | protection springs
- 50 Machine lift | spring return
- 50 Toe cylinder | spring return
- 51 Accessories | 5 tons cylinder
- 51 Accessories | 10 tons cylinder
- 53 Accessories | 15 tons cylinder
- 53 Accessories | 25 tons cylinder
- 54 Accessories | 50 tons cylinder
- 55 Saddles | tilting saddles
- 56 Saddles | thread saddles
- 56 Saddles | flat saddles



HAND TOOLS

- 58 Vertical lifting wedge | spring return
- 58 Wedge | spring return

- 59 Wedge | hydraulic return
- 60 Puller sets | spring return
- 61 Flange spreaders | spring return
- 62 Nut splitters | spring return

LIFTING BAGS

- 64 Lifting bags
- 66 Lifting capacity / height diagrams
- 67 Air hoses
- 68 Accessories | 12 bar
- 69 Accessories | 8 bar

MECHANICAL TOOLS

- 72 Jacks | cast iron
- 73 Jacks | aluminium
- 73 Pulling jacks
- 74 Toe jacks
- 75 Traversing beds
- 76 Base plates
- 76 Ship wedges

ASSIST TOOLS

- 78 Chocks and blocks | set A
- 78 Chocks and blocks | set B

HYDRAULIC PUMPS

- 80 Hand and foot pumps
- 81 Compact air pump | single-acting
- 82 Compact air pump | double-acting
- 83 Compact electric pump
- 84 Vari pumps | configurator
- 85 Vari pumps | 230V - 1-stage
- 86 Vari pumps | 230V - 2-stage
- 87 Vari pumps | 400V - 1-stage
- 88 Vari pumps | 400V - 2-stage
- 89 Vari pumps | twin - 400V - 1-stage
- 90 Vari pumps | air - 1-stage - 8 bars
- 91 Vari pumps | air - 2-stage - 8 bars
- 92 Vari pumps | petrol - 1-stage - 4-stroke
- 93 Vari pumps | petrol - 2-stage - 4-stroke
- 94 Control valves | hand pumps
- 94 Control valves | vari pumps
- 95 Accessories | hand pumps



- 95 Accessories | vari pumps

SYSTEM COMPONENTS

- 98 Hydraulic hoses | single hoses
- 98 Hydraulic hoses | standard hoses
- 99 Hydraulic hoses | extension hoses
- 99 Hydraulic hoses | non-conductive single hoses
- 100 Couplers
- 101 Pressure gauges | scale division in ton
- 102 Pressure gauges | scale division in bars
- 102 Pressure gauges | adaptors
- 103 Pressure gauges | sets
- 104 Valve blocks 'FlowPanel' | single-acting
- 105 Valve blocks 'FlowPanel' | double-acting
- 106 Valves
- 107 Accessories hydraulics
- 109 Assembly materials
- 111 Oils
- 112 Lubricants



TENSIONING HYDRAULICS

- 114 Selection chart
- 115 Stud tension cylinders | including cylinder bridge
- 116 Stud tension cylinders | excluding cylinder bridge
- 118 Pump
- 119 Hydraulic hoses | single hoses - 1000 bars
- 119 Hydraulic hoses | extension hoses - 1000 bars
- 120 Couplers and accessories



PROPELLER SETS

- 122 Propeller cylinders
- 123 Selection chart
- 124 Pump
- 125 Hydraulic hoses | single hoses - 2000 bars
- 125 Hydraulic hoses | extension hoses - 2000 bars
- 126 Couplers and accessories



INDUSTRIAL SOLUTIONS

SERVICE & SAFETY

ABOUT HOLMATRO

Holmatro's hydraulic equipment and systems are used for rescue, special tactics and industrial applications around the world. Still, for over 50 years after the foundation in 1967, we keep honoring our traditional Dutch roots and represent innovation, quality and support. That is why we design, develop, manufacture, and test our tools in-house. Our experience with high-pressure hydraulics enables us to seek out the boundaries of what is technically possible. This has made our tools lighter, compacter, more durable, and easier to use.

The power of innovation

In order to maintain our leading position as a specialist in high-pressure hydraulics, we continuously invest in research and product development. It is our ambition to continue to develop innovative solutions combining extreme power with controllability, user friendliness and safety. Our product development is fully focused on finding result-oriented solutions for specific markets and applications. To achieve this, we closely work together with you, the professional user.

Dutch quality and reliability

We have state-of-the-art production facilities in the Netherlands and the United States to ensure that the high-grade traditional Dutch quality and robustness is maintained. Work is carried out at both locations in accordance with the ISO 9001 Quality Management Standard and the SCC* Safety Health and Environment (SHE) Checklist Contractors. Our products comply with all international standards such as the European EN 13204, EN 13731 and the American NFPA 1936. Holmatro tools are developed, manufactured and maintained in conformity with the highest quality standards of durability, side load, mechanical distortion and overpressure. As they must be resistant to the most extreme conditions, our products are thoroughly tested before they are authorized for use in practice.



200% certainty

Holmatro's hydraulic tools and systems are manufactured using an advanced production process. They contain highly durable components, superior seals and guides, thereby contributing to a longer life span. After production or repair, a technical or maintenance employee tests all our tools. They subsequently undergo an additional test in the Quality Control department. This gives you 200% certainty.

Service and safety

Essential to all Holmatro products is the control of immense power. You must be able to rely on that for every application under any circumstances. Applicable to all brands of hydraulic equipment is that malfunctions and defects will occasionally occur over time. Regular maintenance and correct usage are of great importance in ensuring that your equipment can continue to be employed optimally and safely during its entire operating lifespan. Holmatro can help you here. We offer an extensive service program, training and various supporting resources to work even more safely with hydraulics.

(Inter)national sales network

Besides the headquarters in the Netherlands, Holmatro has state-of-the-art production facilities and sales offices in the Netherlands and the United States. We have a sales office in China and representatives in Germany, Croatia and Poland. Together with our global dealer network who are all fully trained at our own training center, we guarantee the same Holmatro standard of quality and a perfect after-sales service for all of our products all over the world.

INDUSTRIAL TOOLS

The publication you have before you is our Industrial Tools catalogue. It contains a large number of high-pressure hydraulic, pneumatic and mechanical tools. The extensive product range of Industrial Tools includes hydraulic cylinders, lifting tools, hand tools, hydraulic pumps, system components, tensioning hydraulics and propeller sets. All tools are designed for generating and controlling precision power in various industrial applications, such as shipbuilding, heavy transport, maintenance, petrochemical, offshore, construction & installation, mining and civil engineering.



Besides Industrial tools, we also offer:

- **Industrial solutions;** Results-oriented customized hydraulic solutions for loads that are difficult to move with standard tools. This includes challenges relating to lifting, pushing, pulling, lowering, weighing, tilting and horizontal movement.
- **Industrial cutting tools;** Cutting tools specially designed for cutting various materials. Mainly used in cable recycling, vehicles recycling, household appliances recycling and in various demolition industries.
- **Foundry tools;** Foundry wedges for the nodular cast iron industry to remove feeders and risers from castings quickly and safely without damaging the casting itself, and with much less physical effort.
- **Vehicle rescue;** Tools specially made for extricating victims who are trapped after road traffic accidents, involving personal vehicles, transport vehicles, public transportation or defence vehicles.
- **Disaster response rescue;** Disaster Response Rescue solutions support rescuers to generate the immense forces needed during rescue activities after natural or man-made disasters.
- **Special tactics;** Tools designed for Special Tactics operations. These tools are equipped with features such as low visibility, quick and quiet operation and optimal portability.



BASIC KNOWLEDGE OF HYDRAULICS

Pascal's law

Pressure applied at any point upon a confined liquid is transmitted undiminished in all directions (fig. 1).

According to Pascal's law, the oil flow always chooses the line of least resistance in a hydraulic system. This means that when using several hydraulic cylinders, each cylinder lifts at its own speed. When the cylinders have the same capacity, they will first start moving at the point of the lightest load and last at the point of the heaviest load (fig. 2).

A valve block must be added to the lifting system to make sure that the oil flow can be controlled such, that all cylinders operate evenly and the load can be lifted horizontally (fig. 3).

Figure 1

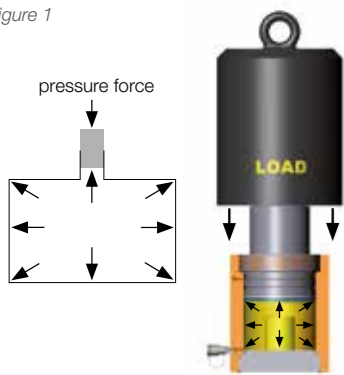

Figure 2



Figure 3



Recommended total cylinder capacity

In connection with various uncertainties as mentioned below, Holmatro recommends a system with sufficient extra capacity:

- The exact weight of the load
- The spreading of the load among the cylinders
- Possible moving of the load in case of calamities

SYMMETRIC LOAD



Recommended total cylinder capacity = 1.5 x load

ASYMMETRIC LOAD



Recommended total cylinder capacity = 2 x load

Force of a cylinder

The force (capacity) generated by a cylinder is equal to the hydraulic pressure multiplied by the effective pressure area of the plunger.

$$\begin{array}{rcl}
 \text{force} & = & \text{hydraulic operating pressure} \times \text{effective pressure area of the plunger} \\
 \text{N} & & \text{N/cm}^2 \quad \times \quad \text{cm}^2 \\
 \mathbf{F} & = & \mathbf{P} \quad \times \quad \mathbf{A} \\
 \text{P} & = & \text{F} \quad / \quad \text{A} \\
 \text{A} & = & \text{F} \quad / \quad \text{P}
 \end{array}$$

This formula can be used for determining the force, pressure or the area when two out of three variables are known.



Recommended total cylinder capacity

Min. eff. tank volume of pump = (oil volume of cylinder 1 + 2 + ...) x 1,2
(safety margin)

Oil volume of cylinder; the volume in cm³ required for achieving the full stroke of the cylinder. For oil volume specifications see section 'Hydraulic cylinders'.

NB. For double-acting cylinders: Reduce the volume above the plunger section with the volume under the plunger section.



Required operating speed

$$\text{Operating speed} = \frac{\text{oil volume of cylinders 1 + 2 + ...}}{\text{pump output}}$$

- Operating speed; with hand/foot pumps: the number of pump strokes required for fully pumping out the cylinder. With motor pumps: the number of minutes required for fully pumping out the cylinder.
 - Oil volume of cylinders; with hand/foot pumps: the volume in cm³ required for achieving the full cylinder stroke. With motor pumps: the volume in litres required for achieving the full cylinder stroke. See table on product pages.
- NB. When two figures are given, only take the value for below or above the plunger part.
- Pump output; with hand/foot pumps: the output of the pump in cm³/stroke. With motor pumps: the output of the pump in l/min. See tables in section 'Hydraulic pumps', for the output of your pump.

Important conversion factors

1	bar	=	1,10197	kg/cm ²
1	bar	=	14,504	psi
1	bar	=	100	kPa
1	bar	=	0,1	MPa
1	bar	=	10	N/cm ²
1	ton	=	9,80665	kN
1	ton	=	9806,65	N
1	ton	=	1000	kg
1	cm ²	=	0,155	in ²
1	cm ³	=	0,06102	in ³
1	cm ³	=	0,001	l
1	kgf	=	9,8066	N
1	kg	=	2,2046	lb



1	kg/cm ²	=	0,98066	bar
1	psi	=	0,0689	bar
1	kPa	=	0,01	bar
1	MPa	=	10	bar
1	N/cm ²	=	0,1	bar
1	kN	=	0,1020	ton
1	N	=	0,0001	ton
1	kg	=	0,001	ton
1	in ²	=	6,4516	cm ²
1	in ³	=	16,3881	cm ³
1	l	=	1000	cm ³
1	N	=	0,1020	kgf
1	lb	=	0,4536	kg



HYDRAULIC CYLINDERS

COMPOSING A HYDRAULIC CYLINDER SYSTEM

3-step plan for composing a hydraulic cylinder system

Step 1

Select one or more cylinders

Considerations:

- What is the weight of the load to be lifted?
- What is the total recommended cylinder capacity?
- With how many cylinders must/can the load be lifted?
- What capacity for each cylinder is required then?
- What is the required stroke length of the cylinder?
- What is the required closed height (overall dimensions) of the cylinder?
- How must the plunger return; gravity, spring or hydraulic?
- Is lifting in one or more steps possible?

See 'Selection list cylinders'

Step 2

Select the proper pump

Considerations:

- Select from hand, foot, pneumatically, electrically, petrol or diesel driven pumps.
- Hand / foot pumps: with a double-acting cylinder (hydraulic return), mount a double-acting valve on your hand pump (only possible with PA *8 models).
- Vari pumps: dependent on whether you use a single- or double-acting cylinder, mount a single-acting or double-acting valve on the Vari pump.
- What minimum tank volume of the pump is required?
- Select a pump output corresponding with the required operating speed.

See section 'Hydraulic pumps'

Step 3

Select the accessories you need

Considerations:

- Choose the correct number of hoses that you need and the required length. Take the required (safe) distance between cylinders and operation (pump and/or valve block) into account.
- When the system contains several cylinders controlled by one pump, we recommend you to install a FlowPanel between the cylinders and the pump for accurate control of the oil flow to the cylinders.
- Select any necessary couplers, pressure gauges, valves and/or assembly material.

See section 'System components'

Four examples of a hydraulic cylinder system

no	description	art no	page
1	hand pump PA 18 H 2	100.142.035	80
2	pressure gauge set for PA *8 pumps	100.182.214	103
3	hydraulic hose H 2 SOU	100.572.102	98
4	single-acting cylinder	-	14
5	hydraulic hose VL 5 SOU	100.572.305	99
6	valve block HMS 4 C	100.172.047	104
7	High Flow coupler, female, A 118	100.181.118	100
8	High Flow coupler, male, A 119	100.181.119	100
9	nipple 3/8" NPT, male	100.581.101	110
10	T-piece	100.001.010	107
11	manifold	100.181.125	108

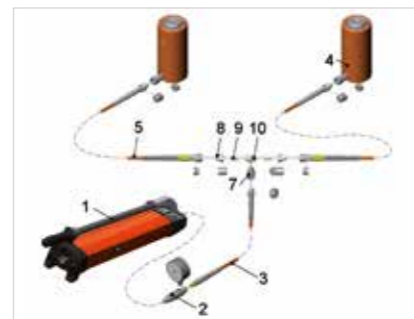
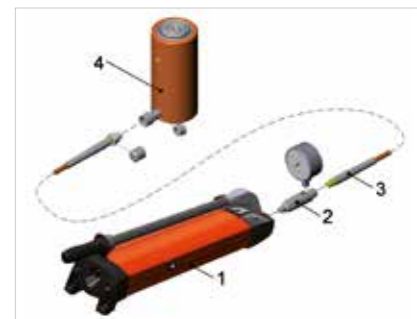
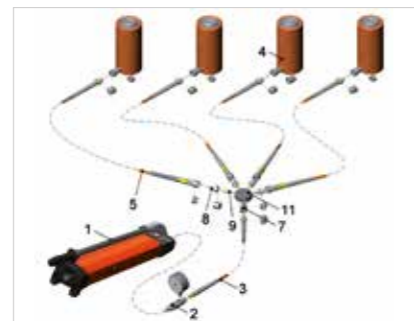

**ANY QUESTIONS?
OUR SALES DEPARTMENT
IS HAPPY TO ASSIST!**

HOLMATRO CYLINDERS

Various return types

The Holmatro product range includes over 200 different cylinders in 10 different types and 3 different return types. A short explanation about the standard return types and the models will be given below.

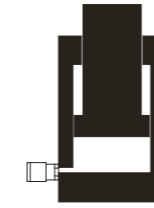

Gravity return

Return of the plunger by means of the load or another external force.

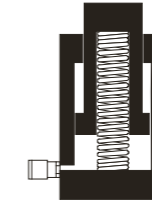

Spring return

Return of the plunger by means of a spring integrated in the cylinder.

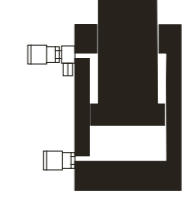

Hydraulic return

Return of the plunger by means of hydraulic pressure. Cylinders in which the plunger hydraulically extends and returns are also called 'double-acting' cylinders.

Various cylinder types



Multi Purpose cylinders - spring return

With a lifting capacity of 5 up to 100 tons and a stroke length varying between 25 and 450 mm the Multi Purpose cylinder range is the most extensive on the market and suitable for the most varied applications. The cylinders are fitted with base mounting holes and collar thread. There is also internal plunger thread on all models to 50 tons.



Aluminium cylinders - spring & hydraulic return

The Aluminium cylinders combine the best of two worlds; They are more than 50% lighter, but are just as robust as their steel equivalent. With a lifting capacity of 20 up to 150 tons and a stroke length varying between 50 and 300 mm the cylinder range is very suitable for lifting activities requiring frequently moving the cylinder, making a low weight essential.



Flat cylinders - spring return

Cylinders with a very low construction height and a lifting capacity of 5 up to 150 tons. Especially developed in case of limited insertion space.



Short Stroke cylinders - spring return

Cylinders with a short stroke, a low construction height and a lifting capacity of 10 up to 100 tons. Very suitable for general lifting activities.



Telescopic cylinders - gravity return

Cylinders with a very low construction height, two different capacities and stroke lengths in one cylinder. Very suitable for various adjustment activities.



High Tonnage cylinders - gravity & hydraulic return

Cylinders with a lifting capacity of 50 up to 500 tons and a stroke length varying between 50 and 300 mm. Very suitable for heavy lifting activities.



Locknut cylinders - gravity & hydraulic return

Cylinders with mechanical load locking, a lifting capacity of 10 up to 500 tons and a stroke length of 50, 150 or 300 mm. Because of the smart return-plunger the hydraulic return locknut cylinders are hardly higher than the gravity return locknut cylinders. All suitable for sustained load because of mechanical load locking.



Construction cylinders - hydraulic return

Cylinders especially for use in combination with extension tubes and accessories, with a lifting capacity of 10 up to 25 tons and a stroke length varying between 150 and 250 mm. These cylinders can be extended using tubes. Various accessories are available. This cylinder type is also suitable for assembly into a construction.



Hollow Plunger cylinders - gravity, spring & hydraulic return

Cylinders with a hollow plunger for both pushing and pulling, with a capacity of 5 up to 110 tons and a stroke length varying between 25 and 150 mm. Especially developed for pulling using pulling rods.



Pulling cylinders - spring & hydraulic return

Cylinders with a pulling capacity of 11 up to 100 tons and a stroke length of 150 mm. Especially developed for, among other things, pulling heavy objects towards each other.

capacity	closed height	stroke	return	type	material	model	art no	page
tons	mm	mm						
5	31	5	spring	flat	steel	HFC 5 S 0.5	100.112.290	24
	44	15	spring	flat	steel	HFC 5 S 1.5	100.112.291	24
	105	25	spring	multi purpose	steel	HGC 5 S 2.5	100.112.211	26
	130	50	spring	multi purpose	steel	HGC 5 S 5	100.112.212	26
	155	75	spring	multi purpose	steel	HGC 5 S 7.5	100.112.213	26
	180	100	spring	multi purpose	steel	HGC 5 S 10	100.112.214	26
	206	125	spring	multi purpose	steel	HGC 5 S 12.5	100.112.215	26
	268	175	spring	multi purpose	steel	HGC 5 S 17.5	100.112.216	26
	318	225	spring	multi purpose	steel	HGC 5 S 22.5	100.112.217	27
10	46	15	spring	flat	steel	HFC 10 S 1.5	100.112.292	24
	49	21 / 20	gravity	telescopic	steel	HFJ 10/30 G 4	100.111.005	34
	97	25	spring	multi purpose	steel	HGC 10 S 2.5	100.112.218	27
	100	50	spring	short stroke	steel	HSC 10 S 5	100.112.300	23
	122	50	spring	multi purpose	steel	HGC 10 S 5	100.112.219	27
	172	100	spring	multi purpose	steel	HGC 10 S 10	100.112.220	27
	240	150	spring	multi purpose	steel	HGC 10 S 15	100.112.221	27
	270	150	gravity	lock nut	steel	HJ 10 G 15 SN	100.082.003	35
	290	200	spring	multi purpose	steel	HGC 10 S 20	100.112.222	27
	327	150	hydraulic	construction	steel	HCJ 10 H 15	100.122.066	42
	340	250	spring	multi purpose	steel	HGC 10 S 25	100.112.223	27
	390	300	spring	multi purpose	steel	HGC 10 S 30	100.112.224	27
	440	350	spring	multi purpose	steel	HGC 10 S 35	100.112.225	27
	490	400	spring	multi purpose	steel	HGC 10 S 40	100.112.226	27
15	123	25	spring	multi purpose	steel	HGC 15 S 2.5	100.112.227	27
	148	50	spring	multi purpose	steel	HGC 15 S 5	100.112.228	27
	198	100	spring	multi purpose	steel	HGC 15 S 10	100.112.229	27
	265	150	spring	multi purpose	steel	HGC 15 S 15	100.112.230	27
	315	200	spring	multi purpose	steel	HGC 15 S 20	100.112.231	27
	365	250	spring	multi purpose	steel	HGC 15 S 25	100.112.232	27
	415	300	spring	multi purpose	steel	HGC 15 S 30	100.112.233	27
	465	350	spring	multi purpose	steel	HGC 15 S 35	100.112.234	27
	515	400	spring	multi purpose	steel	HGC 15 S 40	100.112.235	28
20	55	15	spring	flat	steel	HFC 20 S 1.5	100.112.293	24
	103	50	spring	short stroke	steel	HSC 20 S 5	100.112.301	23
	140	56 / 55	gravity	telescopic	steel	HJ 20/50 G 11	100.112.103	34
	164	50	spring	standard	aluminium	HAC 20 S 5	100.112.267	18
	214	100	spring	standard	aluminium	HAC 20 S 10	100.112.265	18
	264	150	spring	standard	aluminium	HAC 20 S 15	100.112.261	18
25	138	25	spring	multi purpose	steel	HGC 25 S 2.5	100.112.236	28
	165	50	spring	multi purpose	steel	HGC 25 S 5	100.112.237	28
	215	100	spring	multi purpose	steel	HGC 25 S 10	100.112.238	28
	265	150	spring	multi purpose	steel	HGC 25 S 15	100.112.239	28
	283	150	gravity	lock nut	steel	HJ 25 G 15 SN	100.082.002	35
	315	200	spring	multi purpose	steel	HGC 25 S 20	100.112.240	28
	350	150	hydraulic	construction	steel	HCJ 25 H 15	100.122.067	42
	374	250	spring	multi purpose	steel	HGC 25 S 25	100.112.241	28
	424	300	spring	multi purpose	steel	HGC 25 S 30	100.112.242	28
	450	250	hydraulic	construction	steel	HCJ 25 H 25	100.122.068	42
	474	350	spring	multi purpose	steel	HGC 25 S 35	100.112.243	28
	574	450	spring	multi purpose	steel	HGC 25 S 45	100.112.244	28
30	50	5	spring	flat	steel	HFC 30 S 0.5	110.112.294	24

capacity	closed height	stroke	return	type	material	model	art no	page
tons	mm	mm						
30	60	15	spring	flat	steel	HFC 30 S 1.5	100.112.295	24
	106	50	spring	short stroke	steel	HSC 30 S 5	100.112.302	23
	182	50	spring	standard	aluminium	HAC 30 S 5	100.112.269	18
	197	50	hydraulic	standard	aluminium	HAC 30 H 5	100.122.086	20
	232	100	spring	standard	aluminium	HAC 30 S 10	100.112.268	18
	247	100	hydraulic	standard	aluminium	HAC 30 H 10	100.122.085	20
	282	150	spring	standard	aluminium	HAC 30 S 15	100.112.262	18
	297	150	hydraulic	standard	aluminium	HAC 30 H 15	100.122.080	20
	347	200	hydraulic	standard	aluminium	HAC 30 H 20	100.122.079	20
	397	250	hydraulic	standard	aluminium	HAC 30 H 25	100.122.103	20
	447	300	hydraulic	standard	aluminium	HAC 30 H 30	100.122.060	20
35	184	50	spring	multi purpose	steel	HGC 35 S 5	100.112.245	28
	234	100	spring	multi purpose	steel	HGC 35 S 10	100.112.246	28
	284	150	spring	multi purpose	steel	HGC 35 S 15	100.112.247	28
	334	200	spring	multi purpose	steel	HGC 35 S 20	100.112.248	28
50	71	15	spring	flat	steel	HFC 50 S 1.5	100.112.296	25
	117	50	spring	short stroke	steel	HSC 50 S 5	100.112.303	23
	208	50	hydraulic	lock nut	steel	HLC 50 H 5	100.122.123	36
	142	60	gravity	high tonnage	steel	HJ 50 G 6	100.112.073	38
	176	50	spring	multi purpose	steel	HGC 50 S 5	100.112.249	28
	183	50	spring	standard	aluminium	HAC 50 S 5	100.112.271	19
	201	50	hydraulic	standard	aluminium	HAC 50 H 5	100.122.095	21
	226	100	spring	multi purpose	steel	HGC 50 S 10	100.112.250	28
	233	100	spring	standard	aluminium	HAC 50 S 10	100.112.270	19
	251	100	hydraulic	standard	aluminium	HAC 50 H 10	100.122.108	21
	276	150	spring	multi purpose	steel	HGC 50 S 15	100.112.251	28
	282	150	gravity	high tonnage	steel	HJ 50 G 15	100.112.035	38
	282	150	hydraulic	high tonnage	steel	HJ 50 H 15	100.122.002	40
	283	150	spring	standard	aluminium	HAC 50 S 15	100.112.263	19
	301	150	hydraulic	standard	aluminium	HAC 50 H 15	100.122.097	21
	307	150	gravity	lock nut	steel	HJ 50 G 15 SN	100.082.001	35
	327	150	hydraulic	lock nut	steel	HLC 50 H 15	100.122.124	36
	326	200	spring	multi purpose	steel	HGC 50 S 20	100.112.252	28
	351	200	hydraulic	standard	aluminium	HAC 50 H 20	100.122.098	21
	376	250	spring	multi purpose	steel	HGC 50 S 25	100.112.253	19
	401	250	hydraulic	standard	aluminium	HAC 50 H 25	100.122.099	21
	451	300	hydraulic	standard	aluminium	HAC 50 H 30	100.122.100	21
	463	300	gravity	high tonnage	steel	HJ 50 G 30	100.112.036	38
	463	300	hydraulic	high tonnage	steel	HJ 50 H 30	100.122.022	40
	498	300	hydraulic	lock nut	steel	HLC 50 H 30	100.122.125	36
	476	350	spring	multi purpose	steel	HGC 50 S 35	100.112.254	24
75	80	15	spring	flat	steel	HFC 75 S 1.5	100.112.297	25
	285	150	spring	multi purpose	steel	HGC 75 S 15	100.112.255	29
	347	150	gravity	high tonnage	steel	HJ 75 G 15	100.112.037	28
	347	150	hydraulic	high tonnage	steel	HJ 75 H 15	100.122.003	40
	485	350	spring	multi purpose	steel	HGC 75 S 35	100.112.256	29
	497	300	gravity	high tonnage	steel	HJ 75 G 30	100.112.038	38
	497	300	hydraulic	high tonnage	steel	HJ 75 H 30	100.122.004	40
100	90	15	spring	flat	steel	HFC 100 S 1.5	100.112.298	33
	141	50	spring	short stroke	steel	HSC 100 S 5	100.112.304	31
	157	60	gravity	high tonnage	steel	HJ 100 G 6	100.112.093	38

capacity	closed height	stroke	return	type	material	model	art no	page
tons	mm	mm						
100	170	50	hydraulic	high tonnage	steel	HJ 100 H 5	100.122.009	40
	218	50	spring	multi purpose	steel	HGC 100 S 5	100.112.257	29
	225	50	spring	standard	aluminium	HAC 100 S 5	100.112.273	19
	246	50	hydraulic	standard	aluminium	HAC 100 H 5	100.122.094	21
	248	50	hydraulic	lock nut	steel	HLC 100 H 5	100.122.126	36
	268	100	spring	multi purpose	steel	HGC 100 S 10	100.112.258	29
	275	100	spring	standard	aluminium	HAC 100 S 10	100.112.272	19
	296	100	hydraulic	standard	aluminium	HAC 100 H 10	100.122.109	21
	309	150	gravity	high tonnage	steel	HJ 100 G 15	100.112.039	39
	309	150	hydraulic	high tonnage	steel	HJ 100 H 15	100.122.052	40
	318	150	spring	multi purpose	steel	HGC 100 S 15	100.112.259	29
	323	150	gravity	lock nut	steel	HJ 100 G 15 SN	100.082.000	35
	325	150	spring	standard	aluminium	HAC 100 S 15	100.112.264	19
	346	150	hydraulic	standard	aluminium	HAC 100 H 15	100.122.107	21
	370	150	hydraulic	lock nut	steel	HLC 100 H 15	100.122.127	36
	396	200	hydraulic	standard	aluminium	HAC 100 H 20	100.122.088	21
	418	250	spring	multi purpose	steel	HGC 100 S 25	100.112.260	19
	446	250	hydraulic	standard	aluminium	HAC 100 H 25	100.122.089	21
	496	300	hydraulic	standard	aluminium	HAC 100 H 30	100.122.090	21
	497	300	gravity	high tonnage	steel	HJ 100 G 30	100.112.040	39
	497	300	hydraulic	high tonnage	steel	HJ 100 H 30	100.122.054	41
	546	300	hydraulic	lock nut	steel	HLC 100 H 30	100.122.128	36
150	100	15	spring	flat	steel	HFC 150 S 1.5	100.112.299	25
	248	50	hydraulic	standard	aluminium	HAC 150 H 5	100.122.075	23
	275	50	hydraulic	lock nut	steel	HLC 150 H 5	100.122.129	37
	298	100	hydraulic	standard	aluminium	HAC 150 H 10	100.122.074	22
	317	150	gravity	high tonnage	steel	HJ 150 G 15	100.112.046	39
	317	150	hydraulic	high tonnage	steel	HJ 150 H 15	100.122.061	41
	348	150	hydraulic	standard	aluminium	HAC 150 H 15	100.122.073	22
	363	150	gravity	lock nut	steel	HJ 150 G 15 SN	100.112.136	35
	398	200	hydraulic	standard	aluminium	HAC 150 H 20	100.122.070	22
	400	150	hydraulic	lock nut	steel	HLC 150 H 15	100.122.130	37
	448	250	hydraulic	standard	aluminium	HAC 150 H 25	100.122.069	22
	498	300	hydraulic	standard	aluminium	HAC 150 H 30	100.122.064	22
	502	300	gravity	high tonnage	steel	HJ 150 G 30	100.112.047	39
	502	300	hydraulic	high tonnage	steel	HJ 150 H 30	100.122.062	41
	580	300	hydraulic	lock nut	steel	HLC 150 H 30	100.122.131	37
200	327	150	gravity	high tonnage	steel	HJ 200 G 15	100.112.048	39
	327	150	hydraulic	high tonnage	steel	HJ 200 H 15	100.122.071	41
	507	300	gravity	high tonnage	steel	HJ 200 G 30	100.112.049	39
	507	300	hydraulic	high tonnage	steel	HJ 200 H 30	100.122.072	41
250	317	50	hydraulic	lock nut	steel	HLC 250 H 5	100.122.132	37
	385	150	gravity	lock nut	steel	HJ 250 G 15 SN	100.112.083	35
	444	150	hydraulic	lock nut	steel	HLC 250 H 15	100.122.133	37
	625	300	hydraulic	lock nut	steel	HLC 250 H 30	100.122.134	37
300	382	150	gravity	high tonnage	steel	HJ 300 G 15	100.112.050	39
	382	150	hydraulic	high tonnage	steel	HJ 300 H 15	100.122.084	41
	547	300	gravity	high tonnage	steel	HJ 300 G 30	100.112.099	39
	547	300	hydraulic	high tonnage	steel	HJ 300 H 30	100.122.083	41
400	402	150	gravity	high tonnage	steel	HJ 400 G 15	100.112.100	39
	402	150	hydraulic	high tonnage	steel	HJ 400 H 15	100.122.091	41

capacity	closed height	stroke	return	type	material	model	art no	page
tons	mm	mm						
400	572	300	gravity	high tonnage	steel	HJ 400 G 30	100.112.056	39
	572	300	hydraulic	high tonnage	steel	HJ 400 H 30	100.122.092	41
500	442	150	gravity	high tonnage	steel	HJ 500 G 15	100.112.139	39
	442	150	hydraulic	high tonnage	steel	HJ 500 H 15	100.122.043	41
	587	300	gravity	high tonnage	steel	HJ 500 G 30	100.112.138	39
	587	300	hydraulic	high tonnage	steel	HJ 500 H 30	100.122.038	41

SELECTION LIST | hollow plunger cylinders

capacity	Ø hole in plunger	closed height	stroke	return	type	material	model	art no	page
tons	mm	mm	mm						
5	17	87	25	spring	hollow plunger	steel	HHJ 5 S 2.5	100.111.002	44
12	21	156	50	spring	hollow plunger	steel	HHJ 12 S 5	100.111.021	44
	21	298	150	spring	hollow plunger	steel	HHJ 12 S 15	100.111.029	44
17	27	192	50	spring	hollow plunger	steel	HHJ 17 S 5	100.112.023	44
20	27	182	50	spring	hollow plunger	steel	HHJ 20 S 5	100.112.033	44
	27	389	150	spring	hollow plunger	steel	HHJ 20 S 15	100.112.030	44
30	33	120	50	gravity	hollow plunger	steel	HHJ 30 G 5	100.111.053	43
	33	226	75	spring	hollow plunger	steel	HHJ 30 S 7.5	100.112.055	45
	33	285	150	hydraulic	hollow plunger	steel	HHJ 30 H 15	100.122.045	46
	33	362	150	spring	hollow plunger	steel	HHJ 30 S 15	100.112.034	45
45	39	388	150	spring	hollow plunger	steel	HHJ 45 S 15	100.112.061	45
60	45	272	75	spring	hollow plunger	steel	HHJ 60 S 7.5	100.112.081	45
	45	334	200	hydraulic	hollow plunger	steel	HHJ 60 H 20	100.122.031	46
100	54	265	100	hydraulic	hollow plunger	steel	HHJ 100 H 10	100.122.051	46
	54	395	200	hydraulic	hollow plunger	steel	HHJ 100 H 20	100.122.053	46
110	80	315	75	spring	hollow plunger	steel	HHJ 110 S 7.5	100.112.101	45





Features & benefits

- 50% lighter cylinders; easy to work with and better for the welfare of your employees
- Duo Power Ring; seal, bearing and resistance to lateral loads to a maximum of 10% for a longer life span
- The plunger is specially coated with a hardened anodised layer that makes it extremely wear and corrosion resistant
- The XL Saddle optimally protects the plunger and guides the load as effectively as possible
- All cylinders meet the stringent quality requirements that Holmatro enforces for its products
- A range of more than 12 models with different tonnages and stroke lengths
- Almost all cylinders have a handle

Standard supplied with

- High Flow female coupler A 118
- Flat saddle

Available on request

- Collar thread
- Base mounting holes
- Steel plate for protection of the cylinder bottom
- Cylinders manufactured in conformity with customer specifications

Additional information

Aluminium versus steel: aluminium cylinders offer an easy to handle alternative to steel. They should last a lifetime of use in average heavy duty lifting applications.

Tilting saddles	55
Hydraulic pumps	79
Hydraulic hoses	98
Pressure gauges	101

specifications		HAC 50 S 5	HAC 50 S 10	HAC 50 S 15	HAC 100 S 5	HAC 100 S 10	HAC 100 S 15
art no		100.112.271	100.112.270	100.112.263	100.112.273	100.112.272	100.112.264
max. working pressure	bar/Mpa	720 / 72	720 / 72	720 / 72	720 / 72	720 / 72	720 / 72
tonnage	t	50	50	50	100	100	100
stroke	mm	50	100	150	50	100	150
closed height	mm	183	233	283	225	275	325
diameter (B)	mm	130	130	130	189	189	189
capacity	kN/t	510.4 / 52	510.4 / 52	510.4 / 52	1030.6 / 105.1	1030.6 / 105.1	1030.6 / 105.1
effective pressure area	cm ²	70.9	70.9	70.9	143	143	143
required oil content (effective)	cc	354	709	1063	716	1431	2147
connection		A 118	A 118	A 118	A 118	A 118	A 118
cylinder type		standard	standard	standard	standard	standard	standard
acting type		single	single	single	single	single	single
return type		spring	spring	spring	spring	spring	spring
material		aluminium	aluminium	aluminium	aluminium	aluminium	aluminium
weight, ready for use	kg	6.9	8.3	9.6	17.8	20.9	24.1

specifications		HAC 20 S 5	HAC 20 S 10	HAC 20 S 15	HAC 30 S 5	HAC 30 S 10	HAC 30 S 15
art no		100.112.267	100.112.265	100.112.261	100.112.269	100.112.268	100.112.262
max. working pressure	bar/Mpa	720 / 72	720 / 72	720 / 72	720 / 72	720 / 72	720 / 72
tonnage	t	20	20	20	30	30	30
stroke	mm	50	100	150	50	100	150
closed height	mm	164	214	264	182	232	282
diameter (B)	mm	82	82	82	106	106	106
capacity	kN/t	204 / 20.8	204 / 20.8	204 / 20.8	318.1 / 32.4	318.1 / 32.4	318.1 / 32.4
effective pressure area	cm ²	28.3	28.3	28.3	44.2	44.2	44.2
required oil content (effective)	cc	141	283	424	221	442	663
connection		A 118	A 118	A 118	A 118	A 118	A 118
cylinder type		standard	standard	standard	standard	standard	standard
acting type		single	single	single	single	single	single
return type		spring	spring	spring	spring	spring	spring
material		aluminium	aluminium	aluminium	aluminium	aluminium	aluminium
weight, ready for use	kg	2.6	3.2	3.9	4.7	5.9	7.0





Features & benefits

- 50% lighter cylinders; easy to work with and better for the welfare of your employees
- Duo Power Ring; seal, bearing and resistance to lateral loads to a maximum of 10% for a longer life span
- The plunger is specially coated with a hardened anodised layer that makes it extremely wear and corrosion resistant
- The XL Saddle optimally protects the plunger and guides the load as effectively as possible
- All cylinders meet the stringent quality requirements that Holmatro enforces for its products
- A range of more than 24 models with different tonnages and stroke lengths
- Almost all cylinders have a handle

Standard supplied with

- High Flow female coupler A 118
- Flat saddle

Available on request

- Collar thread
- Base mounting holes
- Steel plate for protection of the cylinder bottom
- Cylinders manufactured in conformity with customer specifications

Additional information

Aluminium versus steel: aluminium cylinders offer an easy to handle alternative to steel. They should last a lifetime of use in average heavy duty lifting applications.

Tilting saddles	55
Hydraulic pumps	79
Hydraulic hoses	98
Pressure gauges	101

specifications		HAC 30 H 5	HAC 30 H 10	HAC 30 H 15	HAC 30 H 20	HAC 30 H 25	HAC 30 H 30
art no		100.122.086	100.122.085	100.122.080	100.122.079	100.122.103	100.122.060
max. working pressure	bar/Mpa	720 / 72	720 / 72	720 / 72	720 / 72	720 / 72	720 / 72
tonnage	t	30	30	30	30	30	30
stroke	mm	50	100	150	200	250	300
closed height	mm	197	247	297	347	397	447
diameter (B)	mm	125	125	125	125	125	125
capacity	kN/t	318.1 / 32.4	318.1 / 32.4	318.1 / 32.4	318.1 / 32.4	318.1 / 32.4	318.1 / 32.4
effective pressure area (press)	cm ²	44.2	44.2	44.2	44.2	44.2	44.2
effective pressure area (retract)	cm ²	11	11	11	11	11	11
required oil content (press)	cc	221	442	663	884	1105	1325
required oil content (retract)	cc	55	110	165	220	275	330
connection		A 118	A 118	A 118	A 118	A 118	A 118
cylinder type		standard	standard	standard	standard	standard	standard
acting type		double	double	double	double	double	double
return type		hydraulic	hydraulic	hydraulic	hydraulic	hydraulic	hydraulic
material		aluminium	aluminium	aluminium	aluminium	aluminium	aluminium
weight, ready for use	kg	6.9	8.5	10.2	11.6	13.2	14.7

specifications		HAC 50 H 5	HAC 50 H 10	HAC 50 H 15	HAC 50 H 20	HAC 50 H 25	HAC 50 H 30
art no		100.122.095	100.122.108	100.122.097	100.122.098	100.122.099	100.122.100
max. working pressure	bar/Mpa	720 / 72	720 / 72	720 / 72	720 / 72	720 / 72	720 / 72
tonnage	t	50	50	50	50	50	50
stroke	mm	50	100	150	200	250	300
closed height	mm	201	251	301	351	401	451
diameter (B)	mm	145	145	145	145	145	145
capacity	kN/t	510.4 / 52	510.4 / 52	510.4 / 52	510.4 / 52	510.4 / 52	510.4 / 52
effective pressure area (press)	cm ²	70.9	70.9	70.9	70.9	70.9	70.9
effective pressure area (retract)	cm ²	32.4	32.4	32.4	32.4	32.4	32.4
required oil content (press)	cc	354	709	1063	1418	1772	2127
required oil content (retract)	cc	162	324	486	648	810	972
connection		A 118	A 118	A 118	A 118	A 118	A 118
cylinder type		standard	standard	standard	standard	standard	standard
acting type		double	double	double	double	double	double
return type		hydraulic	hydraulic	hydraulic	hydraulic	hydraulic	hydraulic
material		aluminium	aluminium	aluminium	aluminium	aluminium	aluminium
weight, ready for use	kg	9.5	11.5	13.3	15.4	17.4	19.3

specifications		HAC 100 H 5	HAC 100 H 10	HAC 100 H 15	HAC 100 H 20	HAC 100 H 25	HAC 100 H 30
art no		100.122.094	100.122.109	100.122.107	100.122.088	100.122.089	100.122.090
max. working pressure	bar/Mpa	720 / 72	720 / 72	720 / 72	720 / 72	720 / 72	720 / 72
tonnage	t	100	100	100	100	100	100
stroke	mm	50	100	150	200	250	300
closed height	mm	246	296	346	396	446	496
diameter (B)	mm	195	195	195	195	195	195
capacity	kN/t	1030.6 / 105.1	1030.6 / 105.1	1030.6 / 105.1	1030.6 / 105.1	1030.6 / 105.1	1030.6 / 105.1
effective pressure area (press)	cm ²	143.1	143.1	143.1	143.1	143.1	143.1
effective pressure area (retract)	cm ²	56.5	56.5	56.5	56.5	56.5	56.5
required oil content (press)	cc	716	1431	2147	2863	3579	4294
required oil content (retract)	cc	283	565	848	1131	1414	1696
connection		A 118	A 118	A 118	A 118	A 118	A 118
cylinder type		standard	standard	standard	standard	standard	standard
acting type		double	double	double	double	double	double
return type		hydraulic	hydraulic	hydraulic	hydraulic	hydraulic	hydraulic
material		aluminium	aluminium	aluminium	aluminium	aluminium	aluminium
weight, ready for use	kg	19.7	23.0	26.9	29.9	33.2	36.6

specifications		HAC 150 H 5	HAC 150 H 10	HAC 150 H 15	HAC 150 H 20	HAC 150 H 25	HAC 150 H 30
art no		100.122.075	100.122.074	100.122.073	100.122.070	100.122.069	100.122.064
max. working pressure	bar/Mpa	720 / 72	720 / 72	720 / 72	720 / 72	720 / 72	720 / 72
tonnage	t	150	150	150	150	150	150
stroke	mm	50	100	150	200	250	300
closed height	mm	248	298	348	398	448	498
diameter (B)	mm	235	235	235	235	235	235
capacity	kN/t	1539.5 / 157	1539.5 / 157	1539.5 / 157	1539.5 / 157	1539.5 / 157	1539.5 / 157
effective pressure area (press)	cm ²	213.8	213.8	213.8	213.8	213.8	213.8
effective pressure area (retract)	cm ²	91.1	91.1	91.1	91.1	91.1	91.1
required oil content (press)	cc	1069	2138	3207	4277	5346	6415
required oil content (retract)	cc	456	911	1367	1822	2278	2733
connection		A 118	A 118	A 118	A 118	A 118	A 118
cylinder type		standard	standard	standard	standard	standard	standard
acting type		double	double	double	double	double	double
return type		hydraulic	hydraulic	hydraulic	hydraulic	hydraulic	hydraulic
material		aluminium	aluminium	aluminium	aluminium	aluminium	aluminium
weight, ready for use	kg	27.7	32.3	38.0	41.5	46.1	50.6

SHORT STROKE CYLINDERS | spring return



Features & benefits

- Compact, flat version, efficient in case of limited insertion space
- Usable in all positions
- Protected against ejection of the plunger
- Dirt scraper ring
 - Protects against pollution
 - Increases the life span
- Splined plunger, no saddle needed

Standard supplied with

- High Flow female coupler A 118

Available on request

- Cylinders manufactured in conformity with customer specifications
- Collar thread
- Base mounting holes

Hydraulic pumps	79
Hydraulic hoses	98
Pressure gauges	101



specifications		HSC 10 S 5	HSC 20 S 5	HSC 30 S 5	HSC 50 S 5	HSC 100 S 5
art no		100.112.300	100.112.301	100.112.302	100.112.303	100.112.304
max. working pressure	bar/Mpa	720 / 72	720 / 72	720 / 72	720 / 72	720 / 72
tonnage	t	10	20	30	50	100
stroke	mm	50	50	50	50	50
closed height	mm	100	103	106	117	141
diameter (B)	mm	70	98	104	128	173
capacity	kN/t	99.8 / 10.2	203.6 / 20.8	318.1 / 32.4	510.4 / 52	1030.6 / 105.1
effective pressure area	cm ²	13.9	28.3	44.2	70.9	143.1
required oil content (effective)	cc	69.3	141.4	221	354	716
connection		A 118	A 118	A 118	A 118	A 118
cylinder type		short stroke	short stroke	short stroke	short stroke	short stroke
acting type		single	single	single	single	single
return type		spring	spring	spring	spring	spring
material		steel	steel	steel	steel	steel
weight, ready for use	kg	2.9	5.5	6.1	9.7	22.2

FLAT CYLINDERS | spring return



Features & benefits

- Compact, flat version, efficient in case of limited insertion space
- Usable in all positions
- Standard provided with fixing holes for easy assembly
- Protected against ejection of the plunger
- Dirt scraper ring
 - Protects against pollution
 - Increases the life span
- Splined plunger, no saddle needed

Standard supplied with

- High Flow female coupler A 118

Available on request

- Cylinders manufactured in conformity with customer specifications

Hydraulic pumps	79
Hydraulic hoses	98
Pressure gauges	101

specifications		HFC 50 S 1.5	HFC 75 S 1.5	HFC 100 S 1.5	HFC 150 S 1.5
art no		100.112.296	100.112.297	100.112.298	100.112.299
max. working pressure	bar/Mpa	720 / 72	720 / 72	720 / 72	720 / 72
tonnage	t	50	75	100	150
stroke	mm	5	15	15	15
closed height	mm	71	80	90	100
diameter (B)	mm	140	165	190	215
capacity	kN/t	510.4 / 52	747.9 / 76.3	1030.5 / 105.1	1447.6 / 147.6
effective pressure area	cm ²	70.9	103.9	143.1	201.1
required oil content (effective)	cc	106	156	215	302
connection		A 118	A 118	A 118	A 118
hose		yes			
cylinder type		flat	flat	flat	flat
acting type		single	single	single	single
return type		spring	spring	spring	spring
material		steel	steel	steel	steel
weight, ready for use	kg	7.0	11.0	18.1	25.7

specifications		HFC 5 S 0.5	HFC 5 S 1.5	HFC 10 S 1.5	HFC 20 S 1.5	HFC 30 S 0.5	HFC 30 S 1.5
art no		100.112.290	100.112.291	100.112.292	100.112.293	100.112.294	100.112.295
max. working pressure	bar/Mpa	720 / 72	720 / 72	720 / 72	720 / 72	720 / 72	720 / 72
tonnage	t	5	5	10	20	30	30
stroke	mm	5	15	15	15	5	15
closed height	mm	31	44	46	55	50	60
diameter (B)	mm	60	60	85	100	116	116
capacity	kN/t	50.9 / 5.2	50.9 / 5.2	99.8 / 10.2	203.6 / 20.8	318.1 / 32.4	318.1 / 32.4
effective pressure area	cm ²	7.1	7.1	13.9	28.3	44.2	44.2
required oil content (effective)	cc	4	11	28.8	42.4	22	66.3
connection		A 118	A 118	A 118	A 118	A 118	A 118
hose		yes					
cylinder type		flat	flat	flat	flat	flat	flat
acting type		single	single	single	single	single	single
return type		spring	spring	spring	spring	spring	spring
material		steel	steel	steel	steel	steel	steel
weight, ready for use	kg	1.2	1.0	1.6	2.9	3.6	4.2



MULTI PURPOSE CYLINDERS | spring return



Features & benefits

- A range of 50 models with different tonnages and stroke lengths
- Collar thread and base mounting holes
- Internal plunger thread on all models to 50 tons
- Duplex Power Coating makes the plunger corrosion-resistant
- Duo Power Ring; seal and bearing for long life span
- Thread Protector protects the thread on the cylinder housing
- XL Saddle+ protects the plunger and limits eccentric loads

Standard supplied with

- High Flow female coupler A 118
- Flat saddle

Available on request

- Cylinders manufactured in conformity with customer specifications

Accessories	51
Tilting saddles	55
Hydraulic pumps	79
Hydraulic hoses	98
Pressure gauges	101

specifications		HGC 5 S 2.5	HGC 5 S 5	HGC 5 S 7.5	HGC 5 S 10	HGC 5 S 12.5	HGC 5 S 17.5
art no		100.112.211	100.112.212	100.112.213	100.112.214	100.112.215	100.112.216
max. working pressure	bar/Mpa	720 / 72	720 / 72	720 / 72	720 / 72	720 / 72	720 / 72
tonnage	t	5	5	5	5	5	5
stroke	mm	25	50	75	100	125	175
closed height	mm	105	130	155	180	206	268
diameter (B)	mm	40	40	40	40	40	40
capacity	kN/t	51 / 5.2	51 / 5.2	51 / 5.2	51 / 5.2	51 / 5.2	51 / 5.2
effective pressure area	cm ²	7.1	7.1	7.1	7.1	7.1	7.1
required oil content (effective)	cc	18	35	53	71	88	124
connection		A 118	A 118	A 118	A 118	A 118	A 118
cylinder type		multi purpose	multi purpose	multi purpose	multi purpose	multi purpose	multi purpose
acting type		single	single	single	single	single	single
return type		spring	spring	spring	spring	spring	spring
material		steel	steel	steel	steel	steel	steel
weight, ready for use	kg	1.1	1.3	1.5	1.7	1.8	2.3

specifications		HGC 5 S 22.5	HGC 10 S 2.5	HGC 10 S 5	HGC 10 S 10	HGC 10 S 15	HGC 10 S 20
art no		100.112.217	100.112.218	100.112.219	100.112.220	100.112.221	100.112.222
max. working pressure	bar/Mpa	720 / 72	720 / 72	720 / 72	720 / 72	720 / 72	720 / 72
tonnage	t	5	10	10	10	10	10
stroke	mm	225	25	50	100	150	200
closed height	mm	318	97	122	172	240	290
diameter (B)	mm	40	60	60	60	60	60
capacity	kN/t	51 / 5.2	100 / 10.2	100 / 10.2	100 / 10.2	100 / 10.2	100 / 10.2
effective pressure area	cm ²	7.1	13.9	13.9	13.9	13.9	13.9
required oil content (effective)	cc	159	35	69	139	208	277
connection		A 118	A 118	A 118	A 118	A 118	A 118
cylinder type		multi purpose	multi purpose	multi purpose	multi purpose	multi purpose	multi purpose
acting type		single	single	single	single	single	single
return type		spring	spring	spring	spring	spring	spring
material		steel	steel	steel	steel	steel	steel
weight, ready for use	kg	2.6	2.1	2.5	3.4	4.6	5.5

specifications		HGC 10 S 25	HGC 10 S 30	HGC 10 S 35	HGC 10 S 40	HGC 15 S 2.5	HGC 15 S 5
art no		100.112.223	100.112.224	100.112.225	100.112.226	100.112.227	100.112.228
max. working pressure	bar/Mpa	720 / 72	720 / 72	720 / 72	720 / 72	720 / 72	720 / 72
tonnage	t	10	10	10	10	15	15
stroke	mm	250	300	350	400	25	50
closed height	mm	340	390	440	490	123	148
diameter (B)	mm	60	60	60	60	70	70
capacity	kN/t	100 / 10.2	100 / 10.2	100 / 10.2	100 / 10.2	171 / 17.4	171 / 17.4
effective pressure area	cm ²	13.9	13.9	13.9	13.9	23.8	23.8
required oil content (effective)	cc	346	416	485	554	59	119
connection		A 118	A 118	A 118	A 118	A 118	A 118
cylinder type		multi purpose	multi purpose	multi purpose	multi purpose	multi purpose	multi purpose
acting type		single	single	single	single	single	single
return type		spring	spring	spring	spring	spring	spring
material		steel	steel	steel	steel	steel	steel
weight, ready for use	kg	6.4	7.3	8.1	9.0	3.4	3.9

specifications		HGC 15 S 10	HGC 15 S 15	HGC 15 S 20	HGC 15 S 25	HGC 15 S 30	HGC 15 S 35
art no		100.112.229	100.112.230	100.112.231	100.112.232	100.112.233	100.112.234
max. working pressure	bar/Mpa	720 / 72	720 / 72	720 / 72	720 / 72	720 / 72	720 / 72
tonnage	t	15	15	15	15	15	15
stroke	mm	100	150	200	250	300	350
closed height	mm	198	265	315	365	415	465
diameter (B)	mm	70	70	70	70	70	70
capacity	kN/t	171 / 17.4	171 / 17.4	171 / 17.4	171 / 17.4	171 / 17.4	171 / 17.4
effective pressure area	cm ²	23.8	23.8	23.8	23.8	23.8	23.8
required oil content (effective)	cc	238	356	475	594	713	832
connection		A 118	A 118	A 118	A 118	A 118	A 118
cylinder type		multi purpose	multi purpose	multi purpose	multi purpose	multi purpose	multi purpose
acting type		single	single	single	single	single	single
return type		spring	spring	spring	spring	spring	spring
material		steel	steel	steel	steel	steel	steel
weight, ready for use	kg	4.9	6.4	7.4	8.4	9.4	10.5

MULTI PURPOSE CYLINDERS

specifications		HGC 15 S 40	HGC 25 S 2.5	HGC 25 S 5	HGC 25 S 10	HGC 25 S 15	HGC 25 S 20
art no		100.112.235	100.112.236	100.112.237	100.112.238	100.112.239	100.112.240
max. working pressure	bar/Mpa	720 / 72	720 / 72	720 / 72	720 / 72	720 / 72	720 / 72
tonnage	t	15	25	25	25	25	25
stroke	mm	400	25	50	100	150	200
closed height	mm	515	138	165	215	265	315
diameter (B)	mm	70	85	85	85	85	85
capacity	kN/t	171 / 17.4	239 / 24.4	239 / 24.4	239 / 24.4	239 / 24.4	239 / 24.4
effective pressure area	cm ²	23.8	33.2	33.2	33.2	33.2	33.2
required oil content (effective)	cc	950	83	166	332	498	664
connection		A 118	A 118	A 118	A 118	A 118	A 118
cylinder type		multi purpose	multi purpose	multi purpose	multi purpose	multi purpose	multi purpose
acting type		single	single	single	single	single	single
return type		spring	spring	spring	spring	spring	spring
material		steel	steel	steel	steel	steel	steel
weight, ready for use	kg	11.5	5.5	6.4	8.0	9.4	11.3

specifications		HGC 25 S 25	HGC 25 S 30	HGC 25 S 35	HGC 25 S 45	HGC 35 S 5	HGC 35 S 10
art no		100.112.241	100.112.242	100.112.243	100.112.244	100.112.245	100.112.246
max. working pressure	bar/Mpa	720 / 72	720 / 72	720 / 72	720 / 72	720 / 72	720 / 72
tonnage	t	25	25	25	25	35	35
stroke	mm	250	300	350	450	50	100
closed height	mm	374	424	474	574	184	234
diameter (B)	mm	85	85	85	85	100	100
capacity	kN/t	239 / 24.4	239 / 24.4	239 / 24.4	239 / 24.4	362 / 36.9	362 / 36.9
effective pressure area	cm ²	33.2	33.2	33.2	33.2	50.3	50.3
required oil content (effective)	cc	830	996	1161	1493	251	503
connection		A 118	A 118	A 118	A 118	A 118	A 118
cylinder type		multi purpose	multi purpose	multi purpose	multi purpose	multi purpose	multi purpose
acting type		single	single	single	single	single	single
return type		spring	spring	spring	spring	spring	spring
material		steel	steel	steel	steel	steel	steel
weight, ready for use	kg	13.3	14.9	16.5	19.8	9.3	11.4

specifications		HGC 35 S 15	HGC 35 S 20	HGC 50 S 5	HGC 50 S 10	HGC 50 S 15	HGC 50 S 20
art no		100.112.247	100.112.248	100.112.249	100.112.250	100.112.251	100.112.252
max. working pressure	bar/Mpa	720 / 72	720 / 72	720 / 72	720 / 72	720 / 72	720 / 72
tonnage	t	35	35	35	35	35	35
stroke	mm	150	200	50	100	150	200
closed height	mm	284	334	176	226	276	326
diameter (B)	mm	100	100	127	127	127	127
capacity	kN/t	362 / 36.9	362 / 36.9	510 / 52	510 / 52	510 / 52	510 / 52
effective pressure area	cm ²	50.3	50.3	70.9	70.9	70.9	70.9
required oil content (effective)	cc	754	1005	354	709	1063	1418
connection		A 118	A 118	A 118	A 118	A 118	A 118
cylinder type		multi purpose	multi purpose	multi purpose	multi purpose	multi purpose	multi purpose
acting type		single	single	single	single	single	single
return type		spring	spring	spring	spring	spring	spring
material		steel	steel	steel	steel	steel	steel
weight, ready for use	kg	13.5	15.5	15.1	18.9	22.6	26.4

MULTI PURPOSE CYLINDERS

specifications		HGC 50 S 25	HGC 50 S 35	HGC 75 S 15	HGC 75 S 35	HGC 100 S 5	HGC 100 S 10
art no		100.112.253	100.112.254	100.112.255	100.112.256	100.112.257	100.112.258
max. working pressure	bar/Mpa	720 / 72	720 / 72	720 / 72	720 / 72	720 / 72	720 / 72
tonnage	t	50	50	75	75	100	100
stroke	mm	250	350	150	350	50	100
closed height	mm	376	476	285	485	218	268
diameter (B)	mm	127	127	147	147	175	175
capacity	kN/t	510 / 52	510 / 52	748 / 76.3	748 / 76.3	1031 / 105.1	1031 / 105.1
effective pressure area	cm ²	70.9	70.9	103.9	103.9	143.1	143.1
required oil content (effective)	cc	1772	2481	1558	3635	716	1431
connection		A 118	A 118	A 118	A 118	A 118	A 118
cylinder type		multi purpose	multi purpose	multi purpose	multi purpose	multi purpose	multi purpose
acting type		single	single	single	single	single	single
return type		spring	spring	spring	spring	spring	spring
material		steel	steel	steel	steel	steel	steel
weight, ready for use	kg	30.1	37.5	30.9	50.0	35.3	42.2

specifications		HGC 100 S 15	HGC 100 S 25
art no		100.112.259	100.112.260
max. working pressure	bar/Mpa	720 / 72	720 / 72
tonnage	t	100	100
stroke	mm	150	250
closed height	mm	318	418
diameter (B)	mm	175	175
capacity	kN/t	1031 / 105.1	1031 / 105.1
effective pressure area	cm ²	143.1	143.1
required oil content (effective)	cc	2147	3579
connection		A 118	A 118
cylinder type		multi purpose	multi purpose
acting type		single	single
return type		spring	spring
material		steel	steel
weight, ready for use	kg	50.0	64.1



MULTI PURPOSE CYLINDER | set



Features & benefits

- Consists of:
 - 2x Multi Purpose cylinder, 1x Hydraulic wedge
 - 4x Extension tube
 - 1x Connection socket, 1x Connection nipple
 - 1x Round base plate
 - 1x Cross head, 1x Wedge head
 - 1x Cylinder toe, 1x Plunger toe
 - 1x Plunger adapter, 1x Cylinder body adapter
 - 1x Pump with pressure gauge
 - 1x 2 meter hose with male coupler
 - 1x Storage case

Available on request

- Cylinders manufactured in conformity with customer specifications











specifications	HIK 10 M	
art no	100.062.003	
return type	spring	
material	steel	
weight, ready for use	kg	44.0
dimension A	mm	782
dimension B	mm	287
dimension C	mm	171

Additional information











ATTENTION: Consult the user manual before fitting cylinder accessories to these cylinders. The maximum working pressure and total construction length is restricted when using cylinder accessories!

Multi purpose cylinders	18
Parts	23

MULTI PURPOSE CYLINDER | set parts

parts	description	model	art no
	High quality Multi Purpose Cylinder. Fitted with unique features that considerably lengthen its life span and service life. Offers appropriate solutions for the most varied applications. Holmatro Multi Purpose Cylinders come in 50 models and are available in different capacities and with different stroke lengths.	HGC 10 S 5	100.112.219
	High quality Multi Purpose Cylinder. Fitted with unique features that considerably lengthen its life span and service life. Offers appropriate solutions for the most varied applications. Holmatro Multi Purpose Cylinders come in 50 models and are available in different capacities and with different stroke lengths.	HGC 10 S 15	100.112.221
	Hydraulic wedge, spring return • To lift a load from a flat surface where there is a minimum insertion space available • Highly suitable to carry out maintenance in places that are difficult to access • Applications: lifting machines, dismantling and assembly, adjustment and alignment	HW 1000	100.562.009
	Extension tube • Suitable for HGC 10 and HCJ 10 cylinders • Length: 125 mm • Thread size: 1 1/4" NPT male (2x) • Max. working pressure: 360 bar	125 - HGC 10 / HCJ 10	100.002.984
	Extension tube • Suitable for HGC 10 and HCJ 10 cylinders • Length: 250 mm • Thread size: 1 1/4" NPT male (2x) • Max. working pressure: 360 bar	250 - HGC 10 / HCJ 10	100.002.985
	Extension tube • Suitable for HGC 10 and HCJ 10 cylinders • Length: 500 mm • Thread size: 1 1/4" NPT male (2x) • Max. working pressure: 360 bar	500 - HGC 10 / HCJ 10	100.002.987
	Extension tube • Suitable for HGC 10 and HCJ 10 cylinders • Length: 750 mm • Thread size: 1 1/4" NPT male (2x) • Max. working pressure: 360 bar	750 - HGC 10 / HCJ 10	100.002.989
	Connection socket • To connect 2 extension tubes • Suitable for HGC 10 and HCJ 10 cylinders • Thread size: 1 1/4" NPT female (2x) • Max. working pressure: 360 bar	HGC 10 / HCJ 10	100.002.980
	Connection nipple • To connect accessories to cylinders • Suitable for HGC 10 and HCJ 10 cylinders • Thread size: 1 1/4" NPT male (2x) • Max. working pressure: 360 bar	HGC 10 / HCJ 10	100.002.982
	Round base plate • To mount on bottom side of cylinder • Suitable for HGC 10 and HCJ 10 cylinders • Thread size: 1 1/4" NPT female • Max. working pressure: 360 bar	HGC 10 / HCJ 10	100.002.978

MULTI PURPOSE CYLINDERS

parts	description	model	art no
	<p>Cross head</p> <ul style="list-style-type: none"> To provide better grip Suitable for HGC 10 and HCJ 10 cylinders Thread size: 1 1/4" NPT female Max. working pressure: 360 bar 	HGC 10 / HCJ 10	100.002.966
	<p>Wedge head</p> <ul style="list-style-type: none"> For spreading Suitable for HGC 10 and HCJ 10 cylinders Thread size: 1 1/4" NPT female Max. working pressure: 360 bar 	HGC 10 / HCJ 10	100.002.968
	<p>Cylinder toe</p> <ul style="list-style-type: none"> Suitable for HGC 10 cylinders Thread size: 2 1/4"-14 UNS female Max. working pressure: 144 bar 	HGC 10	100.002.992
	<p>Plunger toe</p> <ul style="list-style-type: none"> Suitable for HGC 10 and HCJ 10 cylinders Thread size: 1 1/4" NPT female Max. working pressure: 144 bar 	HGC 10 / HCJ 10	100.002.991
	<p>Cylinder body adapter</p> <ul style="list-style-type: none"> Suitable for HGC 10 cylinders Thread size: 1 1/4" NPT female Max. working pressure: 360 bar Standard supplied with 2x bolt M8x16 	HGC 10	100.002.969
	<p>Plunger Adapter</p> <ul style="list-style-type: none"> Suitable for HGC 10 cylinders Thread size: 1 1/4" NPT male - 1"-8 UNC male Max. working pressure: 360 bar 	HGC 10	100.002.964
	<p>The PA 04 H 2 is the most compact, single acting, 2 stage hand pump in the hand pump range. The pump is ergonomically designed, has a robust, compact construction, is service- and maintenance-friendly and combines a low operating force with a high oil output. This all combined with a range of handy features makes this pump a worthwhile asset for you and your tools. This pump is ideal when you are working with smaller hydraulic tools and you want to profit from a very high oil output in the first stage (up to 45 bar) to speed things up.</p>	PA 04 H 2	100.142.033
	<p>Standard hose with male coupler A 119 on one side</p>	H 2 SOU	100.572.102
	<p>Pressure gauge set PA 04/09 pump</p> <ul style="list-style-type: none"> 0-720 bars Pointer damped with glycerine Stainless steel Housing Ø 63 mm Including rubber protection cover Connection: 1/4" NPT male 	-	100.182.213
	<p>Carrying storage box of hydraulic jack set HIK 10 M / HRK 10 M</p>	-	150.581.001



TELESCOPIC CYLINDERS | gravity return



Features & benefits

- Compact
- Lightweight
- Usable in all positions
- Protected against ejection of the plunger

Standard supplied with

- High Flow female coupler A 118
- HFJ 10/30 G 4 contains a 30 cm connecting hose with anti-kink spring
- HJ 20/50 G 11 contains a flat saddle

Available on request

- Cylinders manufactured in conformity with customer specifications
- Base mounting holes

Hydraulic pumps	79
Hydraulic hoses	98
Pressure gauges	101

specifications	HFJ 10/30 G 4	HJ 20/50 G 11
art no	100.111.005	100.112.103
max. working pressure	bar/Mpa 720 / 72	720 / 72
tonnage	t 10	20
stroke	mm 41	111
stroke 1st plunger	mm 21	56
stroke 2nd plunger	mm 20	55
closed height	mm 100	103
diameter (B)	mm 120	125
capacity 1st plunger	kN/t 318 / 32.4	510 / 52
capacity 2nd plunger	kN/t 99.7 / 10.2	203.5 / 20.8
effective pressure area 1st plunger	cm ² 44.2	70.8
effective pressure area 2nd plunger	cm ² 13.9	28.3
required oil content (effective)	cc 118	554
connection	A 118	A 118
hose	yes	
cylinder type	telescopic	telescopic
acting type	single	single
return type	gravity	gravity
material	steel	steel
weight, ready for use	kg 4.5	12.5

LOCKNUT CYLINDERS | gravity return



Features & benefits

- Usable in all positions
- Safe because of mechanical load locking
- Suitable for sustained load
- Flat saddle
 - Prevents damage to the plunger
 - Easy to replace with tilting saddle

Standard supplied with

- High Flow female coupler A 118
- Flat saddle

Available on request

- Cylinders manufactured in conformity with customer specifications
- Collar thread
- Base mounting holes

Tilting saddles	55
Hydraulic pumps	79
Hydraulic hoses	98
Pressure gauges	101

specifications	HJ 10 G 15 SN	HJ 25 G 15 SN	HJ 50 G 15 SN	HJ 100 G 15 SN	HJ 150 G 15 SN	HJ 250 G 15 SN
art no	100.082.003	100.082.002	100.082.001	100.082.000	100.112.136	100.112.083
max. working pressure	bar/Mpa 720 / 72	720 / 72	720 / 72	720 / 72	720 / 72	720 / 72
tonnage	t 10	25	50	100	150	250
stroke	mm 150	150	150	150	150	150
closed height	mm 270	283	307	323	363	385
diameter (B)	mm 60	90	135	190	212	300
capacity	kN/t 99.3 / 10.1	238.9 / 24.4	510.3 / 52	1029.3 / 105	1538.9 / 159.9	2493.8 / 254.3
effective pressure area	cm ² 13.8	33.2	70.9	143	213.8	340.6
required oil content (effective)	cc 210	498	1065	2150	3207	5195
connection	A 118	A 118	A 118	A 118	A 118	A 118
cylinder type	lock nut	lock nut	lock nut	lock nut	lock nut	lock nut
acting type	single	single	single	single	single	single
return type	gravity	gravity	gravity	gravity	gravity	gravity
material	steel	steel	steel	steel	steel	steel
weight, ready for use	kg 5.9	14.0	34.0	71.0	101.0	180.0



Features & benefits

- Extreme low closed height and a maximum side load resistance of 10%. Therefore useful for many different applications
- Double-acting for controlled lifting and lowering
- Integrated safety valves for protection against overpressure on return side
- Multiple-start and rounded thread on plunger for a quicker positioning of the locknut and easy dirt removal
- Hard chromed cylinder wall for optimal wear resistance and corrosion protection
- QPQ treated mechanical locknut with optimised grip and 4 tommy bar holes for easy locking and unlocking
- XL Saddle+: QPQ tilting saddle protects the plunger and limits eccentric loads
- Cover plate for keeping water and dirt out of the cylinder when it is stored

Hydraulic pumps	79
Hydraulic hoses	98
Pressure gauges	101

Standard supplied with

- High Flow female coupler A 118
- Tilting saddle

Available on request

- Cylinders manufactured in conformity with customer specifications
- Lower closed height by using a maximum side load resistance of 5%

specifications		HLC 50 H 5	HLC 50 H 15	HLC 50 H 30	HLC 100 H 5	HLC 100 H 15	HLC 100 H 30
art no		100.122.123	100.122.124	100.122.125	100.122.126	100.122.127	100.122.128
max. working pressure	bar/Mpa	720 / 72	720 / 72	720 / 72	720 / 72	720 / 72	720 / 72
tonnage	t	60	60	60	100	100	100
stroke	mm	50	150	300	50	150	300
closed height	mm	208	327	498	249	370	546
diameter (B)	mm	130	130	130	160	160	160
max. side-load resistance	%	10	10	10	10	10	10
capacity	kN/t	578 / 58.9	578 / 58.9	578 / 58.9	1001 / 102.1	1001 / 102.1	1001 / 102.1
effective pressure area (press)	cm ²	80.3	80.3	80.3	139	139	139
effective pressure area (retract)	cm ²	16.7	16.7	16.7	25.9	25.9	25.9
required oil content (effective)	cc	318	954	1909	566	1696	3391
connection		A 118	A 118	A 118	A 118	A 118	A 118
cylinder type		lock nut	lock nut	lock nut	lock nut	lock nut	lock nut
acting type		double	double	double	double	double	double
return type		hydraulic	hydraulic	hydraulic	hydraulic	hydraulic	hydraulic
material		steel	steel	steel	steel	steel	steel
weight, ready for use	kg	19.5	29.5	44.0	35.0	50.0	72.5

specifications		HLC 150 H 5	HLC 150 H 15	HLC 150 H 30	HLC 250 H 5	HLC 250 H 15	HLC 250 H 30
art no		100.122.129	100.122.130	100.122.131	100.122.132	100.122.133	100.122.134
max. working pressure	bar/Mpa	720 / 72	720 / 72	720 / 72	720 / 72	720 / 72	720 / 72
tonnage	t	150	150	150	250	250	250
stroke	mm	50	150	300	50	150	300
closed height	mm	275	400	580	317	444	625
diameter (B)	mm	194	194	194	245	245	160
max. side-load resistance	%	10	10	10	10	10	10
capacity	kN/t	1544 / 157.4	1544 / 157.4	1544 / 157.4	2586 / 263.7	2586 / 263.7	2586 / 263.7
effective pressure area (press)	cm ²	214.3	214.3	214.3	358.9	358.9	358.9
effective pressure area (retract)	cm ²	37.7	37.7	37.7	75.6	75.6	75.6
required oil content (effective)	cc	883	2649	5299	1417	4251	8502
connection		A 118	A 118	A 118	A 118	A 118	A 118
cylinder type		lock nut	lock nut	lock nut	lock nut	lock nut	lock nut
acting type		double	double	double	double	double	double
return type		hydraulic	hydraulic	hydraulic	hydraulic	hydraulic	hydraulic
material		steel	steel	steel	steel	steel	steel
weight, ready for use	kg	56.3	79.0	112.9	103.0	144.0	203.0



HIGH TONNAGE CYLINDERS | gravity return



Features & benefits

- Usable in all positions
- Protected against ejection of the plunger
- Flat saddle
 - Prevents damage to the plunger
 - Easy to replace with tilting saddle

Standard supplied with

- High Flow female coupler A 118
- Flat saddle

Available on request

- Cylinders manufactured in conformity with customer specifications
- Collar thread
- Base mounting holes

Tilting saddles	55
Hydraulic pumps	79
Hydraulic hoses	98
Pressure gauges	101

specifications		HJ 50 G 6	HJ 50 G 15	HJ 50 G 30	HJ 75 G 15	HJ 75 G 30	HJ 100 G 6
art no		100.112.073	100.112.035	100.112.036	100.112.037	100.112.038	100.112.093
max. working pressure	bar/Mpa	720 / 72	720 / 72	720 / 72	720 / 72	720 / 72	720 / 72
tonnage	t	50	50	50	75	75	100
stroke	mm	60	150	300	150	300	60
closed height	mm	142	282	463	347	497	158
diameter (B)	mm	130	130	130	156	156	185
capacity	kN/t	510.3 / 52	510.3 / 52	510.3 / 52	747.9 / 76.3	747.9 / 76.3	1029.3 / 105
effective pressure area	cm ²	70.9	70.9	70.9	103.9	103.9	143
required oil content (effective)	cc	425	1064	2127	1559	3117	860
connection		A 118	A 118	A 118	A 118	A 118	A 118
cylinder type		high tonnage	high tonnage	high tonnage	high tonnage	high tonnage	high tonnage
acting type		single	single	single	single	single	single
return type		gravity	gravity	gravity	gravity	gravity	gravity
material		steel	steel	steel	steel	steel	steel
weight, ready for use	kg	12.5	27.0	39.5	46.0	63.0	29.0

specifications		HJ 100 G 15	HJ 100 G 30	HJ 150 G 15	HJ 150 G 30	HJ 200 G 15	HJ 200 G 30
art no		100.112.039	100.112.040	100.112.046	100.112.047	100.112.048	100.112.049
max. working pressure	bar/Mpa	720 / 72	720 / 72	720 / 72	720 / 72	720 / 72	720 / 72
tonnage	t	100	100	150	150	200	200
stroke	mm	150	300	150	300	150	300
closed height	mm	309	497	317	502	327	507
diameter (B)	mm	178	178	227	227	261	261
capacity	kN/t	1029.3 / 105	1029.3 / 105	1538.9 / 156.9	1538.9 / 156.9	2040.6 / 208.1	2040.6 / 208.1
effective pressure area	cm ²	143	143	213.8	213.8	283.5	283.5
required oil content (effective)	cc	2145	4290	3207	6414	4253	8505
connection		A 118	A 118	A 118	A 118	A 118	A 118
cylinder type		high tonnage	high tonnage	high tonnage	high tonnage	high tonnage	high tonnage
acting type		single	single	single	single	single	single
return type		gravity	gravity	gravity	gravity	gravity	gravity
material		steel	steel	steel	steel	steel	steel
weight, ready for use	kg	51.0	82.0	74.6	125.3	120.0	184.0

specifications		HJ 300 G 15	HJ 300 G 30	HJ 400 G 15	HJ 400 G 30	HJ 500 G 15	HJ 500 G 30
art no		100.112.050	100.112.099	100.112.100	100.112.056	100.112.139	100.112.138
max. working pressure	bar/Mpa	720 / 72	720 / 72	720 / 72	720 / 72	720 / 72	720 / 72
tonnage	t	300	300	400	400	500	500
stroke	mm	150	300	150	300	150	300
closed height	mm	382	547	402	572	442	587
diameter (B)	mm	316	316	358	358	412	412
capacity	kN/t	2933 / 299.1	2933 / 299.1	3750 / 382.4	3750 / 382.4	4994 / 509.2	4994 / 509.2
effective pressure area	cm ²	415	415	530	530	707	707
required oil content (effective)	cc	6225	12450	7950	15900	10605	21210
connection		A 118	A 118	A 118	A 118	A 118	A 118
cylinder type		high tonnage	high tonnage	high tonnage	high tonnage	high tonnage	high tonnage
acting type		single	single	single	single	single	single
return type		gravity	gravity	gravity	gravity	gravity	gravity
material		steel	steel	steel	steel	steel	steel
weight, ready for use	kg	238.0	257.0	322.0	408.0	386.0	511.0





Features & benefits

- Usable in all positions
- Protected against ejection of the plunger
- Flat saddle
 - Prevents damage to the plunger
 - Easy to replace with tilting saddle

Standard supplied with

- High Flow female coupler A 118
- Flat saddle

Available on request

- Cylinders manufactured in conformity with customer specifications
- Collar thread
- Base mounting holes

Tilting saddles	55
Hydraulic pumps	79
Hydraulic hoses	98
Pressure gauges	101

specifications		HJ 50 H 15	HJ 50 H 30	HJ 75 H 15	HJ 75 H 30	HJ 100 H 5	HJ 100 H 15
art no		100.122.002	100.122.022	100.122.003	100.122.004	100.122.009	100.122.052
max. working pressure	bar/Mpa	720 / 72	720 / 72	720 / 72	720 / 72	720 / 72	720 / 72
tonnage	t	50	50	75	75	100	100
stroke	mm	150	300	150	300	50	150
closed height	mm	282	463	347	497	170	309
diameter (B)	mm	130	130	156	156	178	178
capacity	kN/t	510.3 / 52	510.3 / 52	747.9 / 76.3	747.9 / 76.3	1029.3 / 105	1029.3 / 105
effective pressure area (press)	cm ²	70.9	70.9	103.9	103.9	143	143
effective pressure area (retract)	cm ²	20.6	20.6	53.6	53.6	56.6	56.6
required oil content (press)	cc	1064	2127	1559	3117	716	2145
required oil content (retract)	cc	309	620	755	1509	283	848
connection		A 118	A 118	A 118	A 118	A 118	A 118
cylinder type		high tonnage	high tonnage	high tonnage	high tonnage	high tonnage	high tonnage
acting type		double	double	double	double	double	double
return type		hydraulic	hydraulic	hydraulic	hydraulic	hydraulic	hydraulic
material		steel	steel	steel	steel	steel	steel
weight, ready for use	kg	27.0	44.0	46.0	63.0	29.0	53.0

specifications		HJ 100 H 30	HJ 150 H 15	HJ 150 H 30	HJ 200 H 15	HJ 200 H 30	HJ 300 H 15
art no		100.122.054	100.122.061	100.122.062	100.122.071	100.122.072	100.122.084
max. working pressure	bar/Mpa	720 / 72	720 / 72	720 / 72	720 / 72	720 / 72	720 / 72
tonnage	t	100	150	150	200	200	300
stroke	mm	300	150	300	150	300	150
closed height	mm	497	137	502	327	507	382
diameter (B)	mm	178	227	227	261	261	316
capacity	kN/t	1029.3 / 105	1538.9 / 156.9	1538.9 / 156.9	2040.6 / 208.1	2040.6 / 208.1	2933 / 299.1
effective pressure area (press)	cm ²	143	213.8	213.8	283.5	283.5	4154.5
effective pressure area (retract)	cm ²	56.6	110	110	82.5	82.5	131.9
required oil content (press)	cc	4290	3207	6414	4253	8505	6225
required oil content (retract)	cc	1695	1650	3300	1238	2475	1965
connection		A 118	A 118	A 118	A 118	A 118	A 118
cylinder type		high tonnage	high tonnage	high tonnage	high tonnage	high tonnage	high tonnage
acting type		double	double	double	double	double	double
return type		hydraulic	hydraulic	hydraulic	hydraulic	hydraulic	hydraulic
material		steel	steel	steel	steel	steel	steel
weight, ready for use	kg	85.0	76.0	128.0	121.0	186.0	240.0

specifications		HJ 300 H 30	HJ 400 H 15	HJ 400 H 30	HJ 500 H 15	HJ 500 H 30
art no		100.122.083	100.122.091	100.122.092	100.122.043	100.122.038
max. working pressure	bar/Mpa	720 / 72	720 / 72	720 / 72	720 / 72	720 / 72
tonnage	t	300	400	400	500	500
stroke	mm	300	150	300	150	300
closed height	mm	547	402	572	442	587
diameter (B)	mm	316	130	358	412	412
capacity	kN/t	2933 / 299.1	3750 / 382.4	3750 / 382.4	4994 / 509.2	4994 / 509.2
effective pressure area (press)	cm ²	415.5	530.9	530.9	707	707
effective pressure area (retract)	cm ²	131.9	216.7	216.7	360.3	360.3
required oil content (press)	cc	12450	7950	15900	10605	21210
required oil content (retract)	cc	3930	3238	6476	5400	10800
connection		A 118	A 118	A 118	A 118	A 118
cylinder type		high tonnage	high tonnage	high tonnage	high tonnage	high tonnage
acting type		double	double	double	double	double
return type		hydraulic	hydraulic	hydraulic	hydraulic	hydraulic
material		steel	steel	steel	steel	steel
weight, ready for use	kg	360.0	325.0	413.0	390.0	520.0

CONSTRUCTION CYLINDERS | hydraulic return



Features & benefits

- Compact
- Lightweight
- Usable in all positions
- Protected against ejection of the plunger
- Screw-on saddle
 - Prevents damage to the plunger
 - Easy to replace
- Standard fixing thread
 - On plunger head
 - On cylinder housing
 - In cylinder bottom
 - Designed for maximum cylinder load

Standard supplied with

- High Flow female coupler A 118
- Flat saddle

Available on request

- Cylinders manufactured in conformity with customer specifications

specifications		HCJ 10 H 15	HCJ 25 H 15	HCJ 25 H 25
art no		100.122.066	100.122.067	100.122.068
max. working pressure	bar/Mpa	720 / 72	720 / 72	720 / 72
tonnage	t	10	25	25
stroke	mm	150	150	250
closed height	mm	327	350	450
diameter (B)	mm	66	85	85
capacity	kN/t	99.3 / 10.1	238.9 / 24.4	238.9 / 24.4
effective pressure area (press)	cm ²	13.8	33.2	33.2
effective pressure area (retract)	cm ²	6.8	17.3	17.3
required oil content (press)	cc	207	498	829
required oil content (retract)	cc	102	260	432
connection		A 118	A 118	A 118
cylinder type		construction	construction	construction
acting type		double	double	double
return type		hydraulic	hydraulic	hydraulic
material		steel	steel	steel
weight, ready for use	kg	6.1	12.7	18.2

Additional information

ATTENTION: Consult the user manual before fitting cylinder accessories to these cylinders. The maximum working pressure and total construction length is restricted when using cylinder accessories!

Accessories	51
Hydraulic pumps	79
Hydraulic hoses	98
Pressure gauges	101

HOLLOW PLUNGER CYLINDERS | gravity return



Features & benefits

- Compact
- Usable in all positions
- Protected against ejection of the plunger

Standard supplied with

- High Flow female coupler A 118

Available on request

- Cylinders manufactured in conformity with customer specifications
- Collar thread
- Base mounting holes

specifications	HHJ 30 G 5	
art no	100.111.053	
max. working pressure	bar/Mpa	720 / 72
tonnage	t	30
stroke	mm	50
closed height	mm	120
drain plunger (R)	mm	33
capacity	kN/t	293.7 / 29.9
effective pressure area	cm ²	40.8
required oil content (effective)	cc	204
connection	A 118	
cylinder type	hollow plunger	
acting type	single	
return type	gravity	
material	steel	
weight, ready for use	kg	10.0

Hydraulic pumps	79
Hydraulic hoses	98
Pressure gauges	101

HOLLOW PLUNGER CYLINDERS | spring return



Features & benefits

- Compact
- Usable in all positions
- Protected against ejection of the plunger
- Hollow saddle
 - Prevents damage to the plunger
 - Easy to replace with threaded or flat saddle

Thread saddles	56
Flat saddles	56
Hydraulic pumps	79
Hydraulic hoses	98
Pressure gauges	101

Standard supplied with

- High Flow female coupler A 118
- Hollow saddle, with the exception of the HHJ 5 S 2.5, HHJ 12 S 5 and HHJ 12 S 15 cylinders

Available on request

- Cylinders manufactured in conformity with customer specifications
- Collar thread
- Base mounting holes

Accessories

- Saddles: threaded and flat saddles

specifications		HHJ 5 S 2.5	HHJ 12 S 5	HHJ 12 S 15	HHJ 17 S 5	HHJ 20 S 5	HHJ 20 S 15
art no		100.111.002	100.111.021	100.111.029	100.112.023	100.112.033	100.112.030
max. working pressure	bar/Mpa	720 / 72	720 / 72	720 / 72	720 / 72	720 / 72	720 / 72
tonnage	t	5	12	12	17	20	20
stroke	mm	25	50	150	50	50	150
closed height	mm	87	156	298	192	182	389
drain plunger (R)	mm	17	21	21	27	27	27
capacity	kN/t	54.3 / 5.5	126.7 / 12.9	126.7 / 12.9	169.6 / 17.3	223.9 / 22.8	239.9 / 22.8
effective pressure area	cm ²	7.5	17.6	17.6	23.6	31.1	31.1
required oil content (effective)	cc	19	88	264	118	156	467
connection		A 118	A 118	A 118	A 118	A 118	A 118
cylinder type		hollow plunger	hollow plunger	hollow plunger	hollow plunger	hollow plunger	hollow plunger
acting type		single	single	single	single	single	single
return type		spring	spring	spring	spring	spring	spring
material		steel	steel	steel	steel	steel	steel
weight, ready for use	kg	1.9	6.3	11.0	7.3	8.6	18.0

specifications		HHJ 30 S 7.5	HHJ 30 S 15	HHJ 45 S 15	HHJ 60 S 7.5	HHJ 110 S 7.5
art no		100.112.055	100.112.034	100.112.061	100.112.081	100.112.101
max. working pressure	bar/Mpa	720 / 72	720 / 72	720 / 72	720 / 72	720 / 72
tonnage	t	30	30	45	60	110
stroke	mm	75	150	150	75	75
closed height	mm	226	362	388	272	315
drain plunger (R)	mm	33	33	39	45	80
capacity	kN/t	293.7 / 29.9	293.7 / 29.9	453.5 / 46.2	610.4 / 62.2	1107.8 / 113
effective pressure area	cm ²	40.8	40.8	63	84.8	153.9
required oil content (effective)	cc	306	612	945	636	1155
connection		A 118	A 118	A 118	A 118	A 118
cylinder type		hollow plunger	hollow plunger	hollow plunger	hollow plunger	hollow plunger
acting type		single	single	single	single	single
return type		spring	spring	spring	spring	spring
material		steel	steel	steel	steel	steel
weight, ready for use	kg	15.0	25.0	35.5	43.5	78.3



HOLLOW PLUNGER CYLINDERS | hydraulic return



Features & benefits

- Usable in all positions
- Protected against ejection of the plunger
- Protected against overpressure on return side
- Hollow saddle
 - Prevents damage to the plunger
 - Easy to replace with threaded or flat saddle

Standard supplied with

- High Flow female coupler A 118 on inlet port
- High Flow female coupler with pressure relief valve A 418 on outlet port
- Hollow saddle

Available on request

- Cylinders manufactured in conformity with customer specifications
- Collar thread
- Base mounting holes

Accessories

- Saddles: threaded and flat saddles

Thread saddles	56
Flat saddles	56
Hydraulic pumps	79
Hydraulic hoses	98
Pressure gauges	101

specifications		HHJ 30 H 15	HHJ 60 H 20	HHJ 100 H 10	HHJ 100 H 20
art no		100.122.045	100.122.031	100.122.051	100.122.053
max. working pressure	bar/Mpa	720 / 72	720 / 72	720 / 72	720 / 72
tonnage	t	30	60	100	100
stroke	mm	150	200	100	200
closed height	mm	285	334	265	395
drain plunger (R)	mm	33	45	54	54
capacity (press)	kN/t	293.7 / 29.9	610.4 / 62.2	1018.5 / 103.9	1018.5 / 103.9
capacity (retract)	kN/t	131 / 13.4	452.4 / 46.1	706.9 / 72.1	706.9 / 72.1
effective pressure area (press)	cm ²	40.8	84.4	141.5	141.5
effective pressure area (retract)	cm ²	18.2	62.8	98.2	98.2
required oil content (press)	cc	613	1696	1415	2830
required oil content (retract)	cc	274	1256	982	1964
connection		A 118	A 118	A 118	A 118
cylinder type		hollow plunger	hollow plunger	hollow plunger	hollow plunger
acting type		double	double	double	double
return type		hydraulic	hydraulic	hydraulic	hydraulic
material		steel	steel	steel	steel
weight, ready for use	kg	23.0	40.0	53.0	78.0

PULLING CYLINDERS | spring return



Features & benefits

- Compact
- Usable in all positions
- Protected against ejection of the plunger
- Protected against overpressure

Standard supplied with

- High Flow female coupler with pressure relief valve A 418

Available on request

- Cylinders manufactured in conformity with customer specifications
- Collar thread

Accessories

- Pulling eyes and clevis eyes (to be ordered separately, 2 pieces per cylinder)
- Protection spring (to be order separately)

Pulling eyes	49
Clevis eyes	49
Protection spring	49
Hydraulic pumps	79
Hydraulic hoses	98
Pressure gauges	101

specifications		HPJ 11 S 15	HPJ 30 S 15	HPJ 60 S 15
art no		100.131.001	100.131.011	100.131.021
max. working pressure	bar/Mpa	720 / 72	720 / 72	720 / 72
tonnage	t	11	30	60
stroke	mm	150	150	150
closed height (A)	mm	320	470	530
capacity	kN/t	113 / 11.5	298.7 / 30.5	610.4 / 62.2
effective pressure area	cm ²	15.7	41.5	84.8
required oil content (effective)	cc	236	623	1272
connection		A 118	A 118	A 118
cylinder type		pulling	pulling	pulling
acting type		single	single	single
return type		spring	spring	spring
material		steel	steel	steel
weight, ready for use	kg	11.5	26.0	45.0

PULLING CYLINDERS | hydraulic return



Features & benefits

- Compact
- Usable in all positions
- Protected against ejection of the plunger
- Protected against overpressure

Standard supplied with

- High Flow female coupler with pressure relief valve A 418

Available on request

- Cylinders manufactured in conformity with customer specifications
- Collar thread

Accessories

- Pulling eyes and clevis eyes (to be ordered separately, 2 pieces per cylinder)
- Protection spring (to be order separately)

Pulling eyes	49
Clevis eyes	49
Protection spring	49
Hydraulic pumps	79
Hydraulic hoses	98
Pressure gauges	101

specifications		HPJ 100 H 15
art no		100.122.042
max. working pressure	bar/Mpa	720 / 72
tonnage	t	100
stroke	mm	150
closed height (A)	mm	462
capacity (press)	kN/t	1271,9 . 129.7
capacity (retract)	kN/t	953.7 / 97.3
effective pressure area (press)	cm ²	176.7
effective pressure area (retract)	cm ²	132.5
required oil content (press)	cc	2651
required oil content (retract)	cc	1988
connection		A 118
cylinder type		pulling
acting type		double
return type		hydraulic
material		steel
weight, ready for use	kg	75.0

PULLING CYLINDERS | pulling eyes

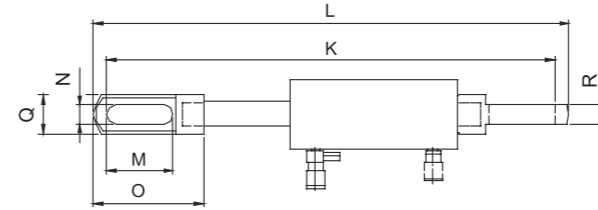

specifications		HPJ 11 S 15	HPJ 30 S 15	HPJ 60 S 15	HPJ 100 H 15
art no		100.181.051	100.181.051	100.181.052	100.181.053
dimension K	mm	760	890	1000	1012
dimension L	mm	810	940	1080	1132
dimension M	mm	120	120	150	200
dimension N	mm	35	35	45	45
dimension O	mm	200	200	260	320
dimension Q	mm	70	70	115	135
dimension R	mm	35	35	40	50

Features & benefits

- Machined from solid steel
- Chemical blacked coating

Additional information

To be ordered separately, 2 pieces per cylinder

PULLING CYLINDERS | clevis eyes

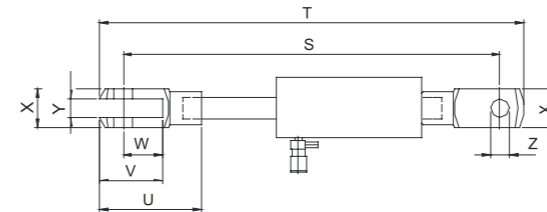

specifications		HPJ 11 S 15	HPJ 30 S 15
art no		100.181.056	100.181.057
dimension S	mm	650	828
dimension T	mm	730	916
dimension U	mm	160	188
dimension V	mm	100	116
dimension W	mm	60	72
dimension X	mm	60	70
dimension Y	mm	30	36
dimension Z	mm	30	35

Features & benefits

- Machined from solid steel
- Complete with pin and quick lock ring
- Specially suitable for use with slings

Additional information

To be ordered separately, 2 pieces per cylinder

PULLING CYLINDERS | protection springs



Features & benefits

- Protects the plunger against dirt and welding spots

Additional information

To be ordered separately

specifications		HPJ 11/30 S 15	HPJ 60 S 15	HPJ 100 H 15
art no		100.581.160	100.581.161	100.581.162

MACHINE LIFT | spring return

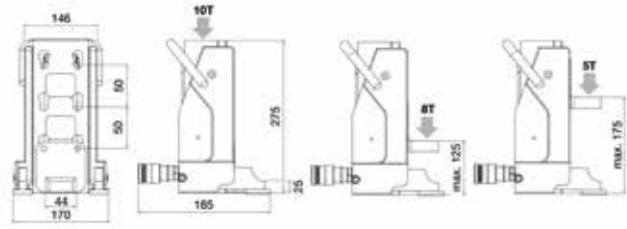

specifications		HMJ 10 S 15 M
art no		100.062.004
max. working pressure	bar/mpa	720 / 72
tonnage	t	10
stroke	mm	145
closed height	mm	275
capacity (head)	kN/t	100 / 10.2
capacity (toe), min.	kN/t	49 / 5
capacity (toe), max.	kN/t	78.5 / 8
required oil content (effective)	cc	208
return type		spring
connection		A 118
weight, ready for use	kg	18.5

Features & benefits

- Toe height adjustable in 3 positions: 25, 100 and 175 mm
- Protected against ejection of the plunger
- Telescopic support legs
- Duplex Power Coating makes the plunger corrosion-resistant
- Duo Power Ring; seal and bearing for long life span

Hydraulic pumps	79
Hydraulic hoses	98
Pressure gauges	101

TOE CYLINDER | spring return

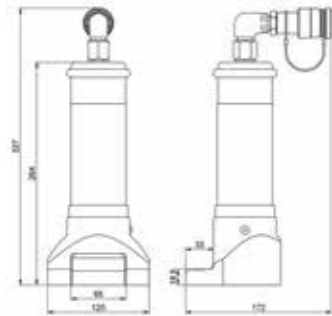









specifications		TJ 8 S 13
art no		100.112.102
max. working pressure	bar/mpa	720 / 72
tonnage	t	8
stroke	mm	130
closed height	mm	319
capacity (toe), min.	kN/t	88.3 / 9
required oil content (effective)	cc	207
return type		spring
connection		A 118
weight, ready for use	kg	6.5

Features & benefits











- Anti-skid profile on the toe
- Usable in all positions
- Compact construction, low weight
- Minimum tip clearance 18.5 mm
- Toe can be rotated 360°

Hydraulic pumps	79
Hydraulic hoses	98
Pressure gauges	101









ACCESSORIES









5 tons cylinder	description	model	art no
	Aluminium base plate • Suitable for HGC 5 and HGC 10 • Max. working pressure: 720 bar • Standard supplied with 2x bolt M8x20 and 2x bolt M6x20	HGC 5 / 10	100.003.004
	Assembly / Welding Ring • Suitable for HGC 5 cylinders • Thread size: 1½"-16 UN • Max. working pressure: 720 bar	HGC 5	100.182.189
10 tons cylinder	description	model	art no
	Plunger Adapter • Suitable for HGC 10 cylinders • Thread size: 1¼" NPT male - 1"-8 UNC male • Max. working pressure: 360 bar	HGC 10	100.002.964
	Cross head • To provide better grip • Suitable for HGC 10 and HCJ 10 cylinders • Thread size: 1¼" NPT female • Max. working pressure: 360 bar	HGC 10 / HCJ 10	100.002.966
	Wedge head • For spreading • Suitable for HGC 10 and HCJ 10 cylinders • Thread size: 1¼" NPT female • Max. working pressure: 360 bar	HGC 10 / HCJ 10	100.002.968
	Cylinder body adapter • Suitable for HGC 10 cylinders • Thread size: 1¼" NPT female • Max. working pressure: 360 bar • Standard supplied with 2x bolt M8x16	HGC 10	100.002.969
	Round base plate • To mount on bottom side of cylinder • Suitable for HGC 10 and HCJ 10 cylinders • Thread size: 1¼" NPT female • Max. working pressure: 360 bar	HGC 10 / HCJ 10	100.002.978
	Connection socket • To connect 2 extension tubes • Suitable for HGC 10 and HCJ 10 cylinders • Thread size: 1¼" NPT female (2x) • Max. working pressure: 360 bar	HGC 10 / HCJ 10	100.002.980
	Connection nipple • To connect accessories to cylinders • Suitable for HGC 10 and HCJ 10 cylinders • Thread size: 1¼" NPT male (2x) • Max. working pressure: 360 bar	HGC 10 / HCJ 10	100.002.982

ACCESSORIES

10 tons cylinder	description	model	art no
	Extension tube • Suitable for HGC 10 and HCJ 10 cylinders • Length: 125 mm • Thread size: 1 1/4" NPT male (2x) • Max. working pressure: 360 bar	125 - HGC 10 / HCJ 10	100.002.984
	Extension tube • Suitable for HGC 10 and HCJ 10 cylinders • Length: 250 mm • Thread size: 1 1/4" NPT male (2x) • Max. working pressure: 360 bar	250 - HGC 10 / HCJ 10	100.002.985
	Extension tube • Suitable for HGC 10 and HCJ 10 cylinders • Length: 500 mm • Thread size: 1 1/4" NPT male (2x) • Max. working pressure: 360 bar	500 - HGC 10 / HCJ 10	100.002.987
	Extension tube • Suitable for HGC 10 and HCJ 10 cylinders • Length: 750 mm • Thread size: 1 1/4" NPT male (2x) • Max. working pressure: 360 bar	750 - HGC 10 / HCJ 10	100.002.989
	Aluminium base plate • Suitable for HGC 5 and HGC 10 • Max. working pressure: 720 bar • Standard supplied with 2x bolt M8x20 and 2x bolt M6x20	HGC 5 / 10	100.003.004
	Plunger toe • Suitable for HGC 10 and HCJ 10 cylinders • Thread size: 1 1/4" NPT female • Max. working pressure: 144 bar	HGC 10 / HCJ 10	100.002.991
	Cylinder toe • Suitable for HGC 10 cylinders • Thread size: 2 1/4" -14 UNS female • Max. working pressure: 144 bar	HGC 10	100.002.992
	Cylinder toe • Suitable for HCJ 10 cylinders • Thread size: M60x2 female • Max. working pressure: 144 bar	10 E	100.002.993
	Screw-on saddle • Suitable for HGC 10 and HCJ 10 cylinders • Thread size: 1 1/4" NPT female	10 D	100.181.091
	Bottom plug • Suitable for HCJ 10 cylinders • Thread size: 1 1/4" NPT male	10 K	100.181.519

ACCESSORIES

10 tons cylinder	description	model	art no
	Assembly / Welding Ring • Suitable for HGC 10 cylinders • Thread size: 2 1/4"-14 UNS • Max. working pressure: 720 bar	HCJ 10	100.182.190
	Assembly / Welding Ring • Suitable for HCJ 10 cylinders • Thread size: M60x2 • Max. working pressure: 720 bar	HCJ 10	100.181.522
15 tons cylinder	description	model	art no
	Aluminium base plate • Suitable for HGC 15 and HGC 25 • Max. working pressure: 720 bar • Standard supplied with 2x bolt M12x30 and 2x bolt M10x30	HGC 15 / 25	100.003.005
25 tons cylinder	description	model	art no
	Plunger Adapter • Suitable for HGC 25 cylinders • Thread size: 2" NPT male - 1 1/2"-16 UN male • Max. working pressure: 360 bar	HGC 25	100.002.965
	Cross head • To provide better grip • Suitable for HGC 25 and HCJ 25 cylinders • Thread size: 2" NPT female • Max. working pressure: 360 bar	HGC 25 / HCJ 25	100.002.967
	Cylinder body adapter • Suitable for HGC 25 cylinders • Thread size: 2" NPT female • Max. working pressure: 360 bar • Standard supplied with 2x bolt M12x20	HGC 25	100.002.970
	Round base plate • To mount on bottom side of cylinder • Suitable for HGC 25 and HCJ 25 cylinders • Thread size: 2" NPT female • Max. working pressure: 360 bar	HGC 25 / HCJ 25	100.002.979
	Connection socket • To connect 2 extension tubes • Suitable for HGC 25 and HCJ 25 cylinders • Thread size: 2" NPT female (2x) • Max. working pressure: 360 bar	HGC 25 / HCJ 25	100.002.981
	Connection Nipple • To connect accessories to cylinders • Suitable for HGC 25 and HCJ 25 cylinders • Thread size: 2" NPT male (2x) • Max. working pressure: 360 bar	HGC 25 / HCJ 25	100.002.983

25 tons cylinder	description	model	art no
	Extension tube • Suitable for HGC 25 and HCJ 25 cylinders • Length: 250 mm • Thread size: 2" NPT male (2x) • Max. working pressure: 360 bar	250 - HGC 25 / HCJ 25	100.002.986
	Extension tube • Suitable for HGC 25 and HCJ 25 cylinders • Length: 500 mm • Thread size: 2" NPT male (2x) • Max. working pressure: 360 bar	500 - HGC 25 / HCJ 25	100.002.988
	Extension tube • Suitable for HGC 25 and HCJ 25 cylinders • Length: 750 mm • Thread size: 2" NPT male (2x) • Max. working pressure: 360 bar	750 - HGC 25 / HCJ 25	100.002.990
	Aluminium base plate • Suitable for HGC 15 and HGC 25 • Max. working pressure: 720 bar • Standard supplied with 2x bolt M12x30 and 2x bolt M10x30	HGC 15 / 25	100.003.005
	Screw-on saddle • Suitable for HGC 25 and HCJ 25 cylinders • Thread size: 2" NPT female	24 D	100.181.092
	Bottom plug • Suitable for HCJ 25 cylinders • Thread size: 2" NPT male	25 K	100.181.569
	Assembly / Welding Ring • Suitable for HGC 25 cylinders • Thread size: 3 5/16"-12 UN • Max. working pressure: 720 bar	HGC 25	100.182.193
	Assembly / Welding Ring • Suitable for HCJ 25 cylinders • Thread size: M85x2 • Max. working pressure: 720 bar	HCJ 25	100.181.572
50 tons cylinder	description	model	art no
	Assembly / Welding Ring • Suitable for HGC 50 cylinders • Thread size: 5"-12 UN • Max. working pressure: 720 bar	HGC 50	100.182.194

SADDLES | tilting saddles



Features & benefits

- Prevents side load on the cylinders up to a maximum angle of 5°
- Hardened material

multi purpose cylinders		TS HGC 5	TS HGC 10	TS HGC 15	TS HGC 25	TS HGC 35	TS HGC 50
art no		100.182.151	100.182.152	100.182.153	100.182.154	100.182.155	100.182.156
cylinder tonnage	t	5	10	15	25	35	50
diameter	mm	20	30	30	45	45	70
additional height (vs flat saddle)	mm	5	5	5	7	7	9

multi purpose cylinders		TS HGC 75	TS HGC 100
art no		100.182.160	100.182.150
cylinder tonnage	t	75	100
diameter	mm	70	105
additional height (vs flat saddle)	mm	9	12

aluminium cylinders		TS HAC 20	TS HAC 30	TS HAC 50	TS HAC 100	TS HAC 150
art no		100.182.164	100.182.163	100.182.165	100.182.159	100.182.161
cylinder tonnage	t	20	30	50	100	150
diameter	mm	45	45	70	105	105
additional height (vs flat saddle)	mm	8	8	9	12	12

high tonnage cylinders		S 50 TN	S 100 TN	S 200 TN	S 500 TN
art no		100.181.043	100.181.044	100.999.040	100.999.232
cylinder tonnage	t	50	100	200	500
diameter	mm	65	90	140	180
additional height (vs flat saddle)	mm	11	11	23	38

locknut cylinders - gravity		S 10 TN	S 25 TN	S 50 TN	S 100 TN	S 200 TN
art no		100.181.041	100.181.042	100.181.043	100.181.044	100.999.040
cylinder tonnage	t	10	25	50	100	200
diameter	mm	35	45	65	90	140
additional height (vs flat saddle)	mm	17	10	11	11	23

SADDLES | thread saddles



Features & benefits

- Perfect to combine with tension rods

Available on request

- Different screw-thread sizes in threaded saddles

hollow plunger cylinders		S 20 C	S 35 C	S 45 C	S 60 C	S 100 C	S 110 C
art no		100.181.013	100.181.016	100.181.019	100.181.022	100.181.025	100.181.028
cylinder tonnage	t	20	30	45	60	100	110
diameter	mm	48	58	63	78	95	125
thread hole	threadsize	1" - 8 UNC	1¼" - 7 UNC	1½" - 8 UNS	1 5/8" - 8 UNS	2" - 8 UNS	2" - 8 UNS

SADDLES | flat saddles



Features & benefits

- Perfect to combine with tension rods

Available on request

- Different screw-thread sizes in threaded saddles

hollow plunger cylinders		S 20 B	S 35 B	S 45 B	S 60 B	S 100 B	S 110 B
art no		100.181.012	100.181.015	100.181.018	100.181.021	100.181.024	100.181.027
cylinder tonnage	t	20	30	45	60	100	110
diameter	mm	48	58	63	78	95	125



HAND TOOLS



VERTICAL LIFTING WEDGE | spring return

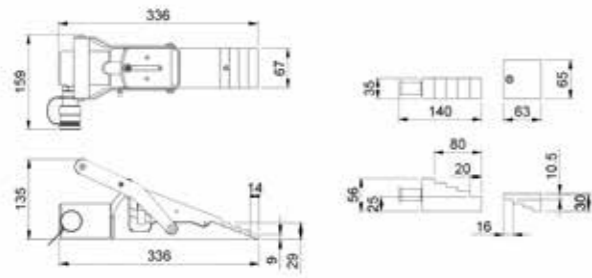

specifications		HVLW 16 S 2
art no		100.112.104
max. working pressure	bar/mpa	720 / 72
tonnage	t	16
min. insertion space	mm	9
lifting stroke	mm	20
max. spreading force	kN/t	156.6 / 16
required oil content (effective)	cc	75
return type		spring
weight, ready for use	kg	8.8

Features & benefits

- 100% vertical lifting movement; prevents misalignment of load
- Automatic mechanical retraction of lifting plate
- Minimum insertion space of 9 mm
- Vertical lifting stroke of 20 mm at each step

Standard supplied with

- Safety block
- Step block
- Grease pistol
- Grease cartridge Molycote®
- Plastic carrying / storage box

Hydraulic pumps	79
Hydraulic hoses	98
Pressure gauges	101

WEDGE | hydraulic return

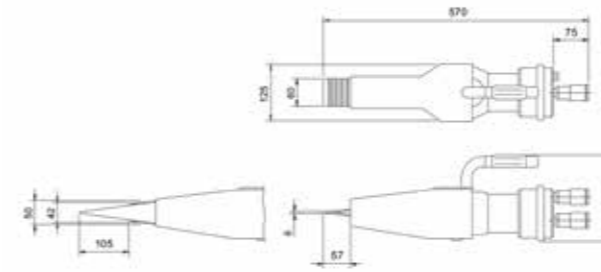

specifications		HWJ 25 U
art no		100.102.021
max. working pressure	bar/mpa	720 / 72
tonnage	t	24
min. insertion space	mm	6
lifting stroke	mm	51
max. spreading force	kN/t	235.4 / 24
required oil content (press)	cc	328
required oil content (retract)	cc	217
return type		hydraulic
weight, ready for use	kg	8.1

Features & benefits

- Minimum insertion space of 6 mm
- Compact construction
- Low weight
- Anti-skid profile on wedge arms
- Usable in all positions

Hydraulic pumps	79
Hydraulic hoses	98
Pressure gauges	101

WEDGE | spring return

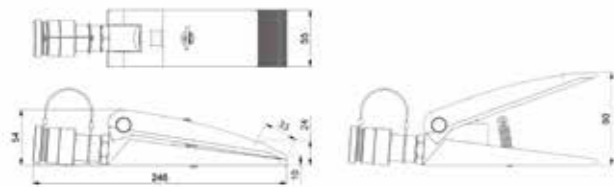

specifications		HW 1000
art no		100.562.009
max. working pressure	bar/mpa	720 / 72
tonnage	t	1
min. insertion space	mm	15
lifting stroke	mm	90
max. spreading force	kN/t	10 / 1
required oil content (effective)	cc	10
return type		spring
weight, ready for use	kg	2.1

Features & benefits

- Compact
- Lightweight
- Anti-skid profile on wedge arms
- Usable in all positions

Hydraulic pumps	79
Hydraulic hoses	98
Pressure gauges	101



PULLER SETS | spring return

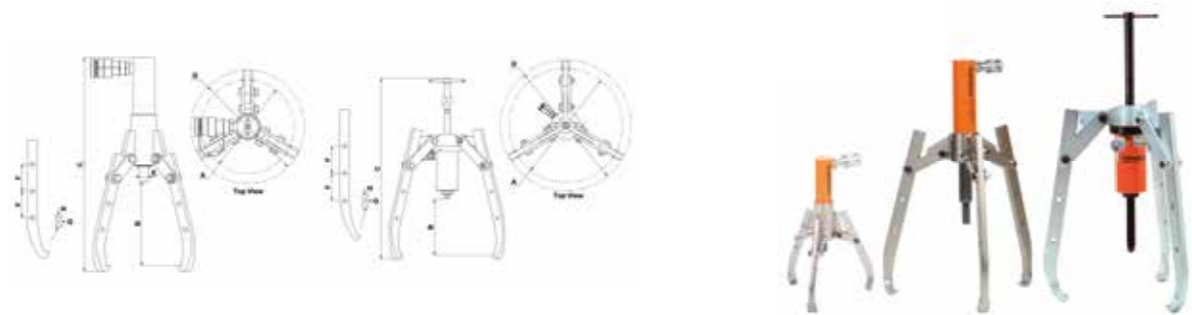

Features & benefits

- Adjustable for broad range of pulleys
- Compact and lightweight
- Usable in all positions

Available on request

- Cylinders manufactured in conformity with customer specifications

Additional information

Puller sets can also be used in combination with cylinders having other stroke lengths

Hydraulic pumps	79
Hydraulic hoses	98
Pressure gauges	101

specifications		HP 5 M	HP 10 M	HP 17	HP 30
art no		100.012.014	100.012.015	100.562.003	100.562.004
required cylinder		HGC 5 S 12.5	HGC 10 S 15	HHj 17 S 5	HHj 30 S 7.5
return type		spring	spring	spring	spring
connection		A 118	A 118	A 118	A 118
weight, excl. cylinder	kg	2.3	8.4	18.5	36.5
weight, incl. cylinder	kg	4.1	13.0	27.5	51.0
dimension A (min.)	mm	30	50	80	100
dimension A (max.)	mm	175	360	390	485
dimension B (min.)	mm	57	157	10	60
dimension B (max.)	mm	157	321	240	310
dimension C (max.)	mm	400	622	950	1200
dimension D (max.)	mm	213	417	490	630
dimension E	mm	16	19		
dimension F	mm	50	82	115	125
dimension G	mm	20	25	32	40
dimension H	mm	7	15	18	22

FLANGE SPREADERS | spring return



Features & benefits

- Safe; no flying off parts or sparks
- Compact and lightweight
- Easy to use
- Two or more can be used for a more equal distribution of forces

Standard supplied with

- High Flow female coupler A 118
- 60° Spreading wedge
- Plastic carrying box, including high-grade grease Molycote®

Available on request

- Spreading wedge with 30° angle:
 - FLS 85 M, art no 100.103.009
 - FLS 170 M, art no 100.103.018
 - FLS 210 M, art no 100.182.141
- Flange spreader with opening larger than 210 mm

Hydraulic pumps	79
Hydraulic hoses	98
Pressure gauges	101

specifications		FLS 85 M	FLS 170 M	FLS 210 M
art no		100.012.011	100.012.012	100.012.013
max. working pressure	bar/Mpa	720 / 72	720 / 72	720 / 72
flange opening 30° wedge (min.)	mm	2	2	2
flange opening 30° wedge (max.)	mm	25	25	25
flange opening 60° wedge (min.)	mm	3	3	3
flange opening 60° wedge (max.)	mm	32	32	32
spreading force 30° wedge	kN/t	73.5 / 7.5	73.5 / 7.5	73.5 / 7.5
spreading force 60° wedge	kN/t	34.3 / 3.5	34.3 / 3.5	34.3 / 3.5
required oil content (effective)	cc	53	53	53
return type		spring	spring	spring
connection		A 118	A 118	A 118
weight, ready for use	kg	4.5	8.0	9.5
weight, incl. case	kg	6.3	9.5	11.0
dimension A	mm	85	170	21
dimension B	mm	15	20	30
dimension C	mm	30	32.8	75
dimension D	mm	129	209	260
dimension E	mm	264	266	309

NUT SPLITTERS | spring return

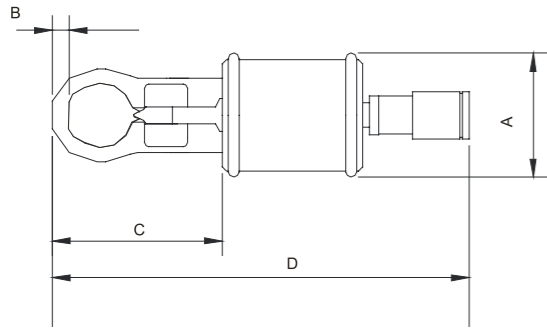

Features & benefits

- Compact
- Lightweight
- Usable in all positions
- Safe; no flying off parts or sparks
- Adjustable blade; prevents damage to the thread

Standard supplied with

- High Flow female coupler A 118
- Plastic carrying box, including:
 - High-grade grease Molycote®
 - Spare blade

Hydraulic pumps	79
Hydraulic hoses	98
Pressure gauges	101

specifications		HNC 1536 NU	HNC 3250 U
art no		100.102.009	100.102.006
max. working pressure	bar/Mpa	720 / 72	720 / 72
min. reach bolt		M12 (1/2")	M22 (7/8")
max. reach category 8 bolt		M24 (3/4")	M33 (1 1/4")
max. reach 2H bolt		M20 (3/4")	M33 (1 1/4")
capacity	kN/t	148 / 15.1	316 / 32.2
required oil content (effective)	cc	32	57
return type		spring	spring
weight, ready for use	kg	2.9	7.2
weight, incl. case	kg	4.2	8.6
thickness cutting head	mm	23	33
dimension A	mm	86	118
dimension B	mm	11	19
dimension C	mm	104	139
dimension D	mm	277	321



LIFTING BAGS





Features & benefits

- Clear indication of safety warnings, technical specifications and lifting height
 - To help you work safer and easier
- Center markings on all sides
 - To help you position a smaller bag onto a larger model
- Non-slip surface with interlocking profile
 - To maximize the contact area and stability of inflated lifting bags
- Reflective markings
 - For optimal visibility in the dark
- Compliant with relevant safety standards
 - Meets EN 13731 and other legislative requirements

Lifting capacity / height diagrams	66
Air hoses	67
Accessories 12 bar	68
Accessories 8 bar	69

Standard supplied with

- Flexible integrated dust cap on air inlet

specifications		HLB 2	HLB 6	HLB 8	HLB 11	HLB 16	HLB 21
art no		350.321.021	350.321.022	350.321.023	350.321.025	350.321.026	350.321.027
max. working pressure	bar/Mpa	12 / 1.2	12 / 1.2	12 / 1.2	12 / 1.2	12 / 1.2	12 / 1.2
max. inflation height	mm	94	141	179	207	236	266
thickness incl. profile	mm	22	22	22	25	25	25
max. lifting capacity	kN/t	21 / 2.1	55 / 5.6	82 / 8.4	110 / 11.2	155 / 15.8	210 / 21.4
max. lifting capacity (12 bar/174 psi)	kN/t	21 / 2.1	55 / 5.6	82 / 8.4	110 / 11.2	155 / 15.8	210 / 21.4
max. lifting capacity (8 bar/116 psi)	kN/t	14 / 1.4	37 / 3.8	55 / 5.6	73 / 7.4	103 / 10.5	133 / 13.6
air content (12 bar/174 psi)	l	9.6	26.4	40	64.8	104.4	161
air content (8 bar/116 psi)	l	6.4	17.6	26.4	43.2	69.6	107.2
water content	l	0.8	22	3.3	5.4	8.7	13.4
connection		ISO 6150 C	ISO 6150 C	ISO 6150 C	ISO 6150 C	ISO 6150 C	ISO 6150 C
min. bursting pressure	bar/Mpa	48 / 4.8	48 / 4.8	48 / 4.8	48 / 4.8	48 / 4.8	48 / 4.8
material		reinforced with 3 aramide inlays	reinforced with 3 aramide inlays	reinforced with 3 aramide inlays	reinforced with 3 aramide inlays	reinforced with 3 aramide inlays	reinforced with 3 aramide inlays
weight, ready for use	kg	0.7	1.6	2.1	3.2	4.5	5.6
dimensions (AxBxC)	mm	200 x 160 x 22	285 x 245 x 22	335 x 295 x 22	403 x 325 x 25	467 x 390 x 25	517 x 440 x 25
temperature range	°C	-20 + 50	-20 + 50	-20 + 50	-20 + 50	-20 + 50	-20 + 50

specifications		HLB 31	HLB 38	HLB 53	HLB 63	HLB 85	HLB 96
art no		350.321.028	350.321.030	350.321.031	350.321.032	350.321.034	350.321.033
max. working pressure	bar/Mpa	12 / 1.2	12 / 1.2	12 / 1.2	12 / 1.2	12 / 1.2	12 / 1.2
max. inflation height	mm	321	352	411	456	550	565
thickness incl. profile	mm	27	27	27	27	27	27
max. lifting capacity	kN/t	306 / 31.2	370 / 37.7	520 / 53	620 / 63.2	855 / 87.2	940 / 95.9
max. lifting capacity (12 bar/174 psi)	kN/t	306 / 31.2	370 / 37.7	520 / 53	620 / 63.2	855 / 87.2	940 / 95.9
max. lifting capacity (8 bar/116 psi)	kN/t	204 / 20.8	247 / 25.2	347 / 35.4	413 / 42.1	570 / 58.1	627 / 63.9
air content (12 bar/174 psi)	l	286	438	692	884	1415	1619
air content (8 bar/116 psi)	l	190.4	296	462	592	943	1079
water content	l	24	37	58	74	118	135
connection		ISO 6150 C	ISO 6150 C	ISO 6150 C	ISO 6150 C	ISO 6150 C	ISO 6150 C
min. bursting pressure	bar/Mpa	48 / 4.8	48 / 4.8	48 / 4.8	48 / 4.8	48 / 4.8	48 / 4.8
material		reinforced with 3 aramide inlays	reinforced with 3 aramide inlays	reinforced with 3 aramide inlays	reinforced with 3 aramide inlays	reinforced with 3 aramide inlays	reinforced with 3 aramide inlays
weight, ready for use	kg	8.6	10.0	15.0	17.0	23.0	25.0
dimensions (AxBxC)	mm	608 x 530 x 27	662 x 585 x 27	767 x 690 x 27	827 x 750 x 27	948 x 870 x 27	987 x 910 x 27
thread hole	threadsize	M6	M6	M6	M6	M6	M6
temperature range	°C	-20 + 50	-20 + 50	-20 + 50	-20 + 50	-20 + 50	-20 + 50



LIFTING CAPACITY / HEIGHT DIAGRAMS | 12 bar

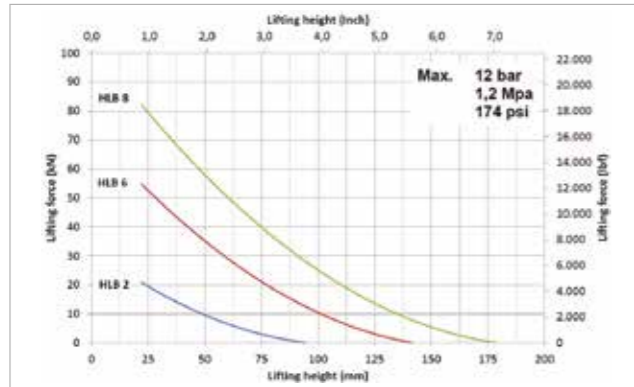

● HLB 2 ● HLB 6 ● HLB 8

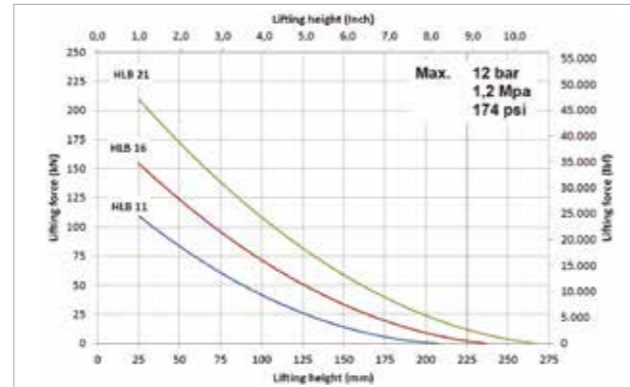

● HLB 11 ● HLB 16 ● HLB 21

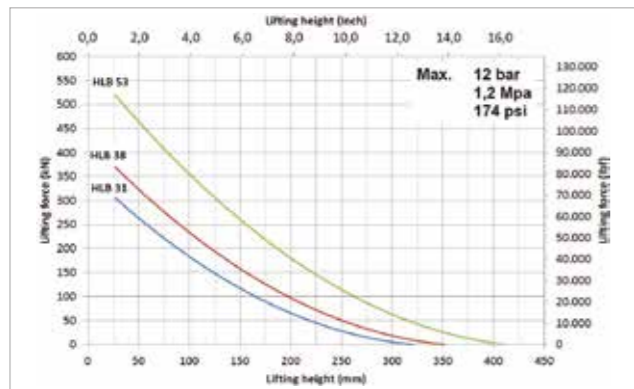

● HLB 31 ● HLB 38 ● HLB 53

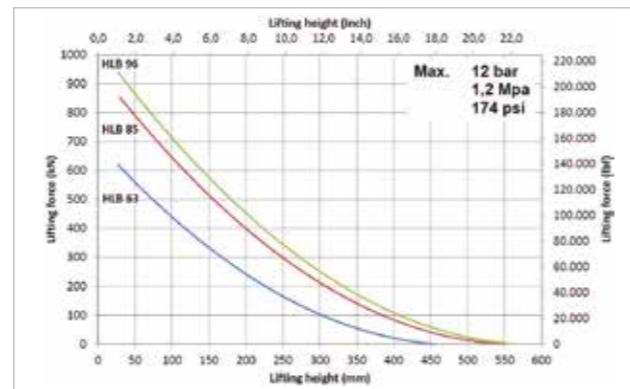

● HLB 63 ● HLB 85 ● HLB 96

LIFTING CAPACITY / HEIGHT DIAGRAMS | 8 bar

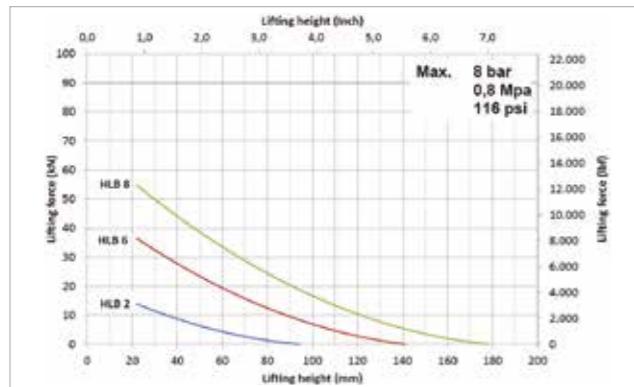

● HLB 2 ● HLB 6 ● HLB 8

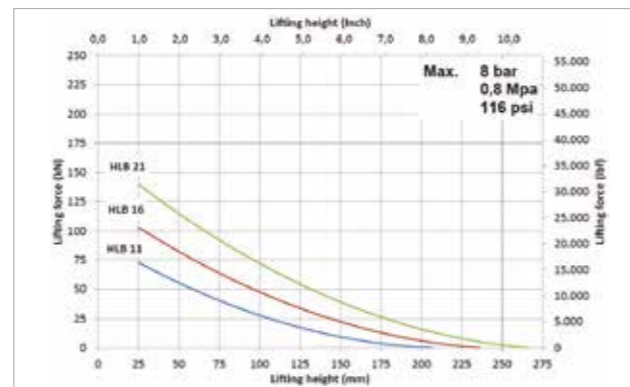

● HLB 11 ● HLB 16 ● HLB 21

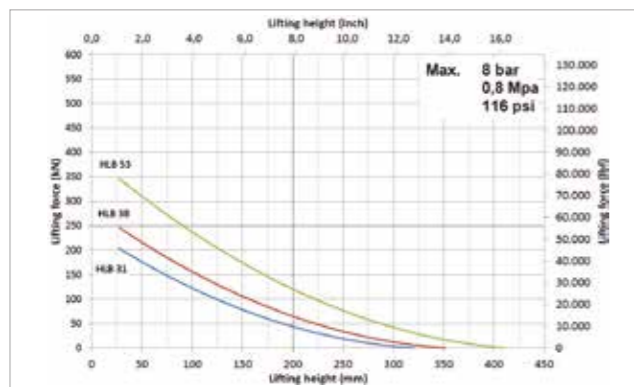

● HLB 31 ● HLB 38 ● HLB 53

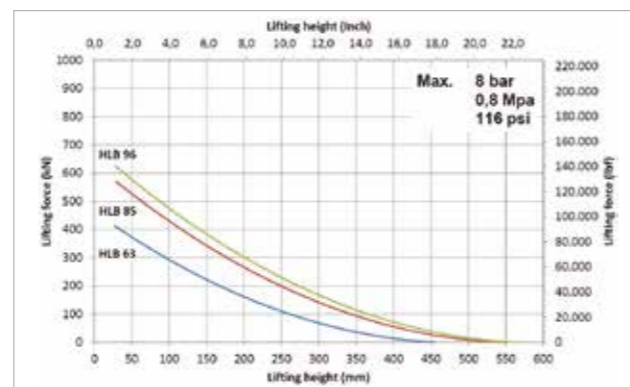

● HLB 63 ● HLB 85 ● HLB 96

AIR HOSES



Features & benefits





- 4:1 safety ratio





air hoses 12 bar	AH 5 O	AH 5 Y	AH 5 B	AH 10 O	AH 10 Y	AH 10 B
art no	350.570.030	350.570.022	350.570.023	350.570.031	350.570.027	350.570.026
max. working pressure	bar/Mpa	12 / 1.2	12 / 1.2	12 / 1.2	12 / 1.2	12 / 1.2
max. air pressure	bar/Mpa	12 / 1.2	12 / 1.2	12 / 1.2	12 / 1.2	12 / 1.2
color		orange	yellow	blue	orange	yellow
length	m	5	5	5	10	10
weight, ready for use	kg	0.8	0.8	0.8	1.4	1.4
temperature range	°C	-20 + 80	-20 + 80	-20 + 80	-20 + 80	-20 + 80

air hoses 8 bar	AH 5 YU	AH 5 BU	AH 5 RU	AH 10 YU	AH 10 BU	AH 10 RU
art no	350.572.006	350.572.007	350.572.008	350.572.009	350.572.011	350.572.012
max. working pressure	bar/Mpa	8 / 0.8	8 / 0.8	8 / 0.8	8 / 0.8	8 / 0.8
color		yellow	blue	red	yellow	blue
length	m	5	5	5	10	10
temperature range	°C	-20 + 80	-20 + 80	-20 + 80	-20 + 80	-20 + 80

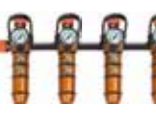

ACCESSORIES | 12 bar



control units	description	model	art no
	Control unit for operation of one or two high pressure lifting bags <ul style="list-style-type: none"> Designed for safe and controlled lifting Working pressure 12 bar / 174 psi 	HDC 12	350.182.095
	Single control unit <ul style="list-style-type: none"> For the control of 1 high-pressure lifting bag Safety valves set at 12 bar / 174 psi 	SCV 12	350.182.110
	Double control unit <ul style="list-style-type: none"> For the control of 2 high-pressure lifting bags Safety valves set at 12 bar / 174 psi 	DCV 12	350.182.111
	Triple control unit <ul style="list-style-type: none"> For the control of 3 high-pressure lifting bags Safety valves set at 12 bar / 174 psi 	TCV 12	350.182.121
	Quadruple control unit <ul style="list-style-type: none"> For the control of 4 high-pressure lifting bags Safety valves set at 12 bar / 174 psi 	QCV 12	350.182.122

accessories	description	model	art no
	Shut-off hose with safety valve for 12 bar lifting bags <ul style="list-style-type: none"> To shut off inflated high-pressure lifting bags Allows you to remove the hose, controller and air source from the working area With safety coupler: unlocks in two steps to release pressure before hose disconnection 	SOH 12	350.182.096
	Air adapter <ul style="list-style-type: none"> Female coupler, 12 bar / 174 psi Male coupler, 8 bar / 116 psi To connect your 12 bar lifting bag to an 8 bar lifting system 	AA F12 M8	350.182.107
	Air adapter <ul style="list-style-type: none"> Two male couplers, 12 bar / 174 psi To connect your 12 bar lifting bag system to a 12 bar compressor system 	AA M12 M12	350.000.160
	Air adapter set <ul style="list-style-type: none"> Air adapter AA M12 M12 Air adapter AA M12 M8 Air adapter AA F12 M8 To connect 12 bar / 174 psi and 8 bar / 116 psi lifting systems 	AAS 12	151.000.223









accessories	description	model	art no
	Air bottle, 300 bar, 6 litres <ul style="list-style-type: none"> For use with all air operated tools and pumps 	-	350.581.096
	Pressure reducer for air bottles of 300 bar <ul style="list-style-type: none"> Complete with 2 m hose 	PRV 12	350.182.100
	Lifting eyes set (2 pcs) <ul style="list-style-type: none"> To attach a rope for easy maneuvering of your lifting bag 	-	350.182.129
	Slider pads set (3 pcs) <ul style="list-style-type: none"> For easy insertion of a lifting bag underneath an object 	-	151.000.180

control sets	description	model	art no
	Air control set <ul style="list-style-type: none"> Synthetic carrying/storage case with control unit, hoses, shut-off hoses, pressure reducer, air adapters and connection piece for 300 bar air bottles Everything you need to operate your 12 bar/ 174 psi lifting bags 	ACS 12	350.182.125

ACCESSORIES | 8 bar

control units	description	model	art no
	Control unit for operation of one or two high pressure lifting bags <ul style="list-style-type: none"> Designed for safe and controlled lifting Working pressure 8 bar / 116 psi 	HDC 8	350.182.102
	Single control unit <ul style="list-style-type: none"> For the control of 1 high-pressure lifting bag Safety valves set at 8.5 bars 	SCV 10 U	350.582.042
	Double control unit <ul style="list-style-type: none"> For the control of 2 high-pressure lifting bags Safety valves set at 8.5 bars 	DCV 10 U	350.582.034

ACCESSORIES

control units	description	model	art no
	Triple control unit • For the control of 3 high-pressure lifting bags • Safety valves set at 8.5 bars	TCV 10 U	350.582.059
	Quadruple control unit • For the control of 4 high-pressure lifting bags • Safety valves set at 8.5 bars	QCV 10 U	350.582.060
accessories	description	model	art no
	Shut-off hose with safety • To close high-pressure lifting bags while remaining under pressure in order to use hose and air source elsewhere	-	350.582.035
	Air adapter • Female coupler, 12 bar / 174 psi • Male coupler, 8 bar / 116 psi • To connect your 12 bar lifting bag to an 8 bar lifting system	AA F12 M8	350.182.107
	Adapter set • Synthetic carrying/storage case with various adapters for connecting high pressure lifting bags to various air sources	UAS 10	350.582.050
	Air bottle, 300 bar, 6 litres • For use with all air operated tools and pumps	300 bar	350.581.096
	Pressure reducer • For both 200 and 300 air bottles • Complete with hose 2 m	PRV 823 AU	350.182.002
control sets	description	model	art no
	Air control set • Synthetic orange carrying/storage case with control unit, hoses, shut-off hose, pressure reducer and connection piece for air bottles 300 bar	DCS 10 U_300	350.582.039

MECHANICAL TOOLS



JACKS | cast iron



Features & benefits

- Made of cast iron; resistant to continuous heavy operating conditions
- Unique ratchet handle for engagement both wheel and plunger
- Self-locking; for safe working
- Robust; can be used close to welding works and under water
- Low maintenance
- A range of 13 models with different capacities and stroke lengths

Standard supplied with

- Handle bar

Traversing beds	75
Base plates	76

specifications		JJ 1015	JJ 1513	JJ 2513	JJ 2525	JJ 2533	JJ 3020
art no		200.401.001	200.401.011	200.401.021	200.102.001	200.102.005	200.102.002
tonnage	t	10	15	25	25	25	30
stroke	mm	150	125	125	250	330	200
closed height	mm	280	255	255	395	485	350
capacity	kN/t	98.1 / 10	147.2 / 15	245.3 / 25	245.3 / 25	245.3 / 25	294 / 30
weight, ready for use	kg	12.0	12.0	16.0	21.0	25.0	26.0

specifications		JJ 3513	JJ 3525	JJ 3535	JJ 5013	JJ 5025	JJ 5035
art no		200.401.031	200.102.003	200.102.006	200.401.041	200.102.004	200.102.007
tonnage	t	35	35	35	50	50	50
stroke	mm	130	250	350	130	250	350
closed height	mm	280	410	535	290	445	555
capacity	kN/t	343.4 / 35	343.4 / 35	343.4 / 35	490.5 / 50	490.5 / 50	490.5 / 50
weight, ready for use	kg	24.0	32.0	37.0	31.0	42.0	47.0

specifications		JJ 10011
art no		200.401.051
tonnage	t	100
stroke	mm	105
closed height	mm	310
capacity	kN/t	981 / 100
weight, ready for use	kg	75.0

JACKS | aluminium



Features & benefits

- Compact and lightweight construction; easy to work with and better for the welfare of your employees
- Special sliding pad instead of ball bearings
- Self-locking; for safe working
- Extendable handle bar
- All jacks have a handle

specifications		AJ 1008	AJ 1510	AJ 2510
art no		200.401.004	200.401.003	200.401.002
tonnage	t	10	15	25
stroke	mm	80	100	100
closed height	mm	175	200	200
capacity	kN/t	100 / 10.2	150 / 15.3	250 / 25.5
weight, ready for use	kg	6.1	6.8	9.5

PULLING JACKS

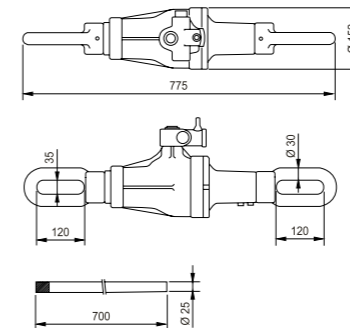

specifications		PL 2510
art no		200.421.001
tonnage	t	25
stroke	mm	100
retracted length	mm	775
capacity	kN/t	245.3 / 25
weight, ready for use	kg	32.0

Features & benefits

- Made of cast iron; resistant to continuous heavy operating conditions
- Unique ratchet handle for engagement both wheel and plunger
- Pulling eyes and an handle bar
- Self-locking; for safe working
- Robust; can be used close to welding works and under water
- Usable in all positions
- Low maintenance

TOE JACKS

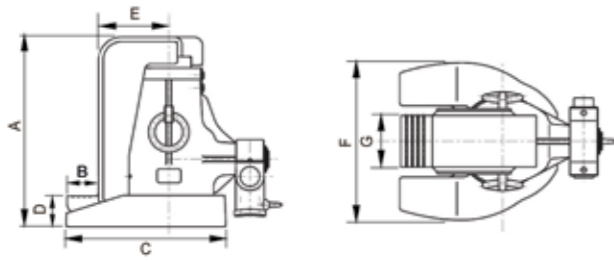

Features & benefits

- Made of cast iron; resistant to continuous heavy operating conditions
- Unique ratchet handle for engagement both wheel and plunger
- Self-locking; for safe working
- Robust; can be used close to welding works and under water

specifications		NJ 0615	NJ 1013	NJ 1513	NJ 2513
art no		200.102.022	200.102.023	200.102.024	200.102.025
tonnage	t	6	10	15	25
stroke	mm	150	125	125	130
closed height	mm	310	290	297	332
capacity	kN/t	60 / 6.1	100 / 10.2	150 / 15.3	250 / 25.5
weight, ready for use	kg	23.0	29.0	38.0	60.0
dimension A	mm	310	290	297	332
dimension B	mm	45	50	50	55
dimension C	mm	208	227	242	280
dimension D	mm	30	40	45	55
dimension E	mm	85	93	101	123
dimension F	mm	195	210	230	275
dimension G	mm	70	75	80	90



TRAVERSING BEDS

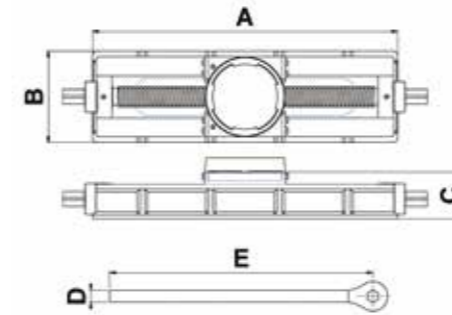

Features & benefits

- Made of cast iron; resistant to continuous heavy operating conditions
- Screw shaft and handle bar; for easy operating
- Self-locking; for safe working
- Robust; can be used close to welding works and under water
- Low maintenance

Additional information

ATTENTION: Cannot be used with JJ 10011, aluminium mechanical jacks and mechanical toe jacks!

specifications		TB 1030	TB 1530	TB 2530	TB 2545	TB 3530	TB 3545
art no		200.102.008	200.102.009	200.102.010	200.102.011	200.102.012	200.102.013
suitable for jack		JJ 1015	JJ 1513	JJ 25**	JJ 25**	JJ 30** / JJ 35**	JJ 30** / JJ 35**
max. horizontal displacement	mm	300	300	300	450	450	450
weight, ready for use	kg	20.0	20.0	25.0	31.0	33.0	38.0
dimension A	mm	465	465	470	620	505	655
dimension B	mm	165	165	185	185	200	200
dimension C	mm	85	85	90	90	97	97
dimension D	mm	24	24	30	30	30	30
dimension E	mm	535	535	600	600	600	600

specifications		TB 5030	TB 5045
art no		200.102.014	200.102.0015
suitable for jack		JJ 50**	JJ 50**
max. horizontal displacement	mm	300	450
weight, ready for use	kg	43.0	66.0
dimension A	mm	530	670
dimension B	mm	210	220
dimension C	mm	108	128
dimension D	mm	30	30
dimension E	mm	600	600

BASE PLATES

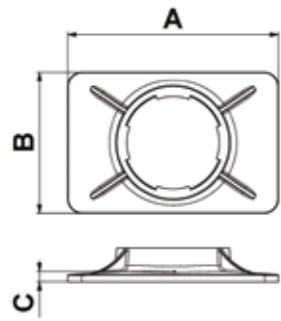

Features & benefits

- Made of cast iron; resistant to continuous heavy operating conditions
- Robust; can be used close to welding works and under water
- Low maintenance

Additional information

ATTENTION: Cannot be used with JJ 10011, aluminium mechanical jacks and mechanical toe jacks!

specifications		SB 10	SB 15	SB 25	SB 35	SB 50
art no		200.102.016	200.102.017	200.102.018	200.102.020	200.102.021
suitable for jack		JJ 1015	JJ 1513	JJ 25**	JJ 30** / JJ 35**	JJ 50**
weight, ready for use	kg	2.0	5.0	7.5	9.5	20.0
dimension A	mm	220	240	300	300	400
dimension B	mm	180	190	200	220	300
dimension C	mm	10	12	15	18	19

SHIP WEDGES

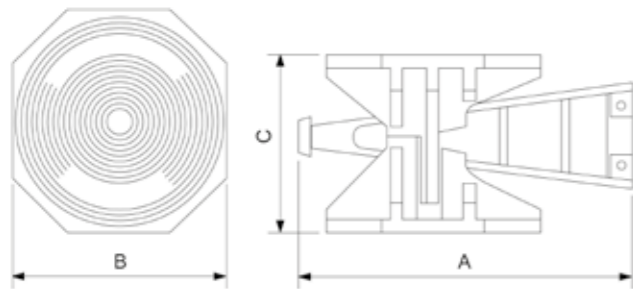

Features & benefits

- Unloads in one go with maximum load
- Robust; resistant to continuous heavy operating conditions
- Can be used close to welding works
- Low maintenance

specifications		W 50	W 80
art no		500.501.050	500.501.080
max. height	mm	225	340
min. height	mm	200	275
capacity	kN/t	490.5 / 50	784.8 / 80
weight, ready for use	kg	29.0	64.5
dimension (AxBxC)	mm	390 x 255 x 200	570 x 345 x 275

ASSIST TOOLS



CHOCKS AND BLOCKS | set A

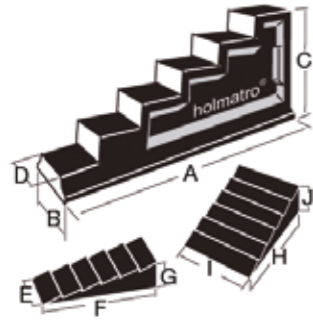

specifications	Set A	
art no		150.562.010
weight, ready for use	kg	15.6

Features & benefits

- Environment-friendly; made of recycled polyethylene and 100% re-usable
- Longer life span than wood; virtually indestructible through one piece moulding
- Non-absorbent material; total resistance to water and oil
- Stackable; non-slip with unique surface profile design
- Extra grip due to elasticity of material under load
- Higher surface pressure allowed; supports 100 kg/cm² in all directions
- Lightweight; floats on water
- Safe; no splintering

Standard supplied with

- 2 x step chock (6,3 kg, art no 150.563.060), 2 x wedge (small, 0,5 kg, art no 150.563.049) and 2 x wedge (large, 1,0 kg, art no 150.563.050)

CHOCKS AND BLOCKS | set B

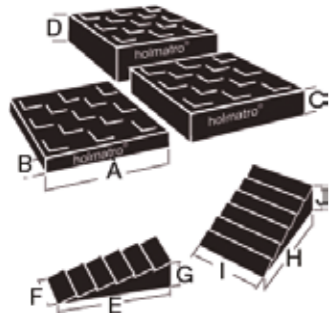

specifications	Set B	
art no		150.562.004
weight, ready for use	kg	15.0

Features & benefits

- Environment-friendly; made of recycled polyethylene and 100% re-usable
- Longer life span than wood; virtually indestructible through one piece moulding
- Non-absorbent material; total resistance to water and oil
- Stackable; non-slip with unique surface profile design
- Extra grip due to elasticity of material under load
- Higher surface pressure allowed; supports 100 kg/cm² in all directions
- Lightweight; floats on water
- Safe; no splintering

Standard supplied with

- 2x wedge (small, 0,5 kg, art no 150.563.049), 2x wedge (large, 1,0 kg, art no 150.563.050), 2x lock block (low, 1,0 kg, art no 150.563.061), 2x lock block (medium, 2,0 kg, art no 150.563.071) and 2x lock block (high, 3,0 kg, art no 150.563.073)



HYDRAULIC PUMPS

HAND AND FOOT PUMPS



Features & benefits

- Ergonomic design
 - Light weight; easy to carry and operate
 - Low operating force required; minimal user effort
 - Soft-grip handles; more comfort and grip
 - Anti-slip rubber underneath; pump is stable and does not shift
 - Pump handle lock; easy and safe to carry
- Service- and maintenance-friendly; technical parts are easy to access and replace without removing the tank
- High oil output; quicker action both in the first and second stage
- Accurately adjustable pressure release valve; loads can be lowered safely and with extreme control
- Pressure gauge connection on the pump block; the pressure gauge can be directly mounted on the pump at an angle of 45 degrees, making it easily readable
- Oil level glass in the tank; easily check the oil level in both horizontal and vertical position
- Integrated filler funnel; top up oil easily and quickly without extra accessories
- Push & Unlock pump handle lock; unlocking is quick and easy with one brief push on the pump handle

Control valves	94
Accessories	95
Hydraulic hoses	98
Pressure gauge set	103
Valve blocks 'FlowPanel'	104

specifications	PA 04 H 2	PA 09 H 2	PA 18 H 2	PA 38 H 2	PA 58 H 2	PA 18 F 2
art no	100.142.033	100.142.034	100.142.035	100.142.037	100.142.038	100.142.036
max. working pressure	bar/Mpa 720 / 72	720 / 72	720 / 72	720 / 72	720 / 72	720 / 72
capacity oil tank (effective)	cc 400	900	1800	3800	5800	1800
capacity oil tank	cc 500	1000	1990	4150	6150	1990
first stage output (per stroke)	cc 18.4	22	42.8	42.8	50.5	42.8
second stage output (per stroke)	cc 1.4	2.1	3.1	3.1	4	3.1
first stage press range	bar/Mpa 0-45 / 0-4.5	0-45 / 0-4.5	0-45 / 0-4.5	0-45 / 0-4.5	0-45 / 0-4.5	0-45 / 0-4.5
second stage pressure range	bar/Mpa 45-720 / 4.5-72	45-720 / 4.5-72	45-720 / 4.5-72	45-720 / 4.5-72	45-720 / 4.5-72	45-720 / 4.5-72
max. operating force	kg 32.0	33.0	35.0	35.0	34.0	37.0
connection	3/8" NPT female	3/8" NPT female	3/8" NPT female	3/8" NPT female	3/8" NPT female	3/8" NPT female
operator type	hand	hand	hand	hand	hand	foot
double acting optional	no	no	yes	yes	yes	yes
weight, ready for use	kg 3.4	4.7	7.6	11.4	14.6	8.3
dimension A	mm 434	619	700	700	897	724
dimension B	mm 135	135	169	183	182	169
dimension C	mm 165	170	175	175	185	167

COMPACT AIR PUMP | single-acting

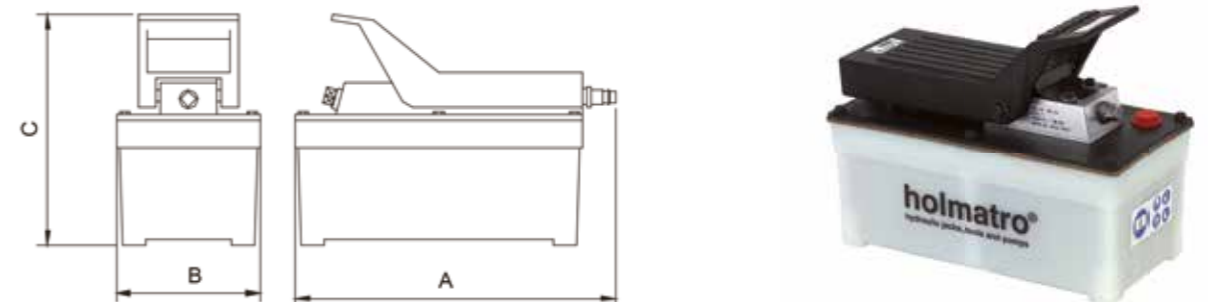

specifications	AHS 1400 FS	
art no	100.602.001	
max. working pressure	bar/Mpa	720 / 72
output unloaded	cc/min	960
output loaded	cc/min	410
air consumption unloaded	l/min	700
air consumption loaded	l/min	580
capacity oil tank (effective)	cc	1400
max. air pressure	bar/Mpa	8.5 / 0.8
connection	3/8" NPT female	
operator type	air	
suitable for (tool type)	single acting	
weight, ready for use	kg	6.5
temperature range	°C	-20 + 55
dimension (AxBxC)	mm	282 x 128 x 200

Features & benefits

- Usable at any place because of compact construction
- Lightweight
- Safe; when the air pressure is lost, the oil pressure is maintained
- Spark-free; suitable for explosive rooms
- Low-noise because of built-in silencer
- Energy-saving; stops as soon as the maximum pressure has been reached

Standard supplied with

- Compressed air connector

Hydraulic hoses	98
Pressure gauges	101
Valve blocks 'FlowPanel'	104



COMPACT AIR PUMP | double-acting

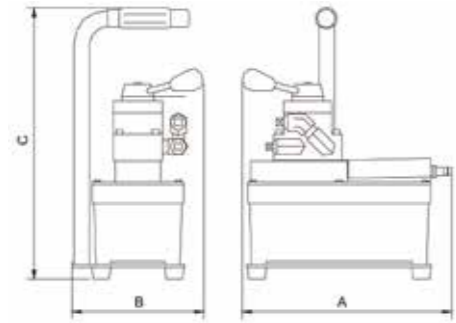

specifications		AHS 1400 D
art no		100.602.002
max. working pressure	bar/Mpa	720 / 72
output unloaded	cc/min	960
output loaded	cc/min	410
air consumption unloaded	l/min	700
air consumption loaded	l/min	580
capacity oil tank (effective)	cc	1400
max. air pressure	bar/Mpa	8.5 / 0.8
connection		3/8" NPT female
operator type		air
suitable for (tool type)		double acting
weight, ready for use	kg	9.6
temperature range	°C	-20 + 55
dimension (AxBxC)	mm	315 x 180 x 372

Features & benefits

- Usable at any place because of compact construction
- Lightweight
- Spark-free; suitable for explosive rooms
- Low-noise because of built-in silencer
- Energy-saving; stops as soon as the maximum pressure has been reached
- Unsuitable for lifting applications, because the pump has no load holding valve

Standard supplied with

- Compressed air connector

Hydraulic hoses	98
Pressure gauges	101
Valve blocks 'FlowPanel'	104

COMPACT ELECTRIC PUMP

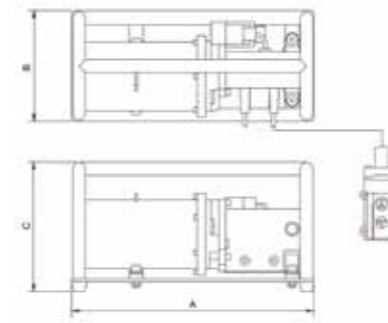

specifications		EHW 1650 RC
art no		100.551.001
max. working pressure	bar/Mpa	720 / 72
first stage output / min.	cc	2000
second stage output / min.	cc	250
capacity oil tank (effective)	cc	1650
connection		3/8" NPT female
engine		230 VAC - 0.35 kW - 50 Hz - 1 Ph
charge remote control	V	15
weight, ready for use	kg	11.6
dimension (AxBxC)	mm	416 x 190 x 222

Features & benefits

- Usable at any place because of compact construction
- Lightweight
- For both horizontal and vertical use
- Perfectly suitable for cable cutters and nut crackers
- Suitable for single-acting tools and cylinders
- With option 3 the pump is suitable for lifting applications

Standard supplied with

- Waterproof (IP 54) Remote Control with 2.3 m long electric cord

Additional information

- Option 1: Needle valve for controlled oil return (art no 100.182.157)
- Option 2: Pressure gauge for reading the pressure (art no 100.182.158)
- Option 3: Needle valve and pressure gauge (art no 100.182.162)



VARI PUMPS | configurator

5-step plan for selection of vari pumps

- Step 1**
Select the power source.
- Air motor
 - Electric motor (230 V - 1 ph - 50 Hz)
 - Electric motor (400 V - 3 ph - 50 Hz)
 - Petrol engine
- Step 2**
Select pump type.
- 1-stage
 - 2-stage for higher operating speed
 - Twin, with 2 independant outlets
- Step 3**
Select the correct content for the oil tank.
- Step 4**
Select the correct pump output in litres per minute.
- Step 5**
Select the correct control valve (for twin pumps 2 valves required).
- For single-acting tools:
- M 311 (hand operation)
- For double-acting tools:
- M 322 (hand operation)
 - M 323 (hand operation with deadman's handle)
 - M 325 (air-powered operation)
 - M 326 (electro-magnetic operation)

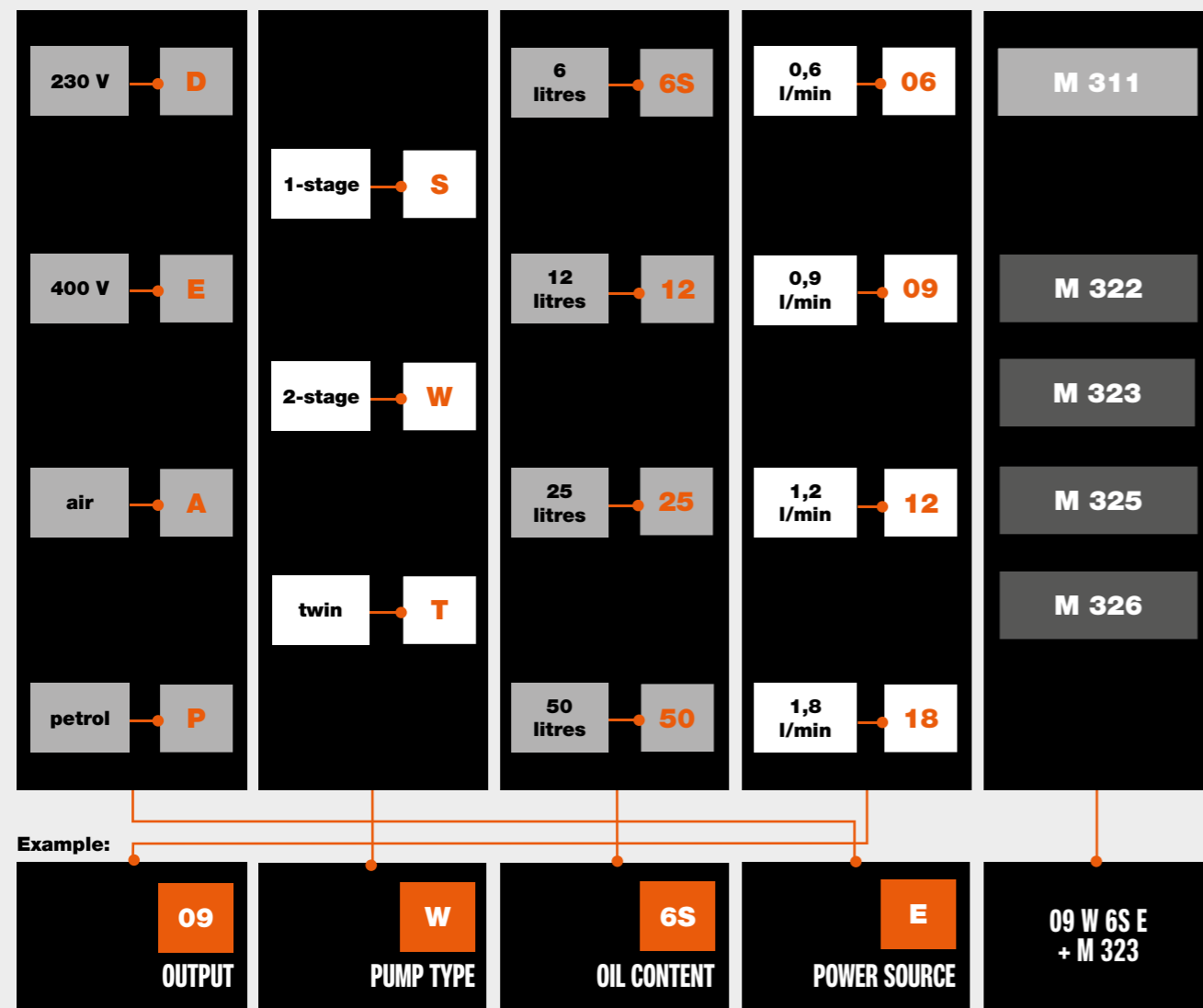

YOU NOW HAVE A FUNCTIONAL PUMP

Do not forget to specify the couplers and/or hoses

Control valves	94
Accessories	95
Hydraulic hoses	98
Pressure gauges	101

VARI PUMPS | 230V - 1-stage



Features & benefits

- Safe
 - In case of a power failure, the oil pressure is maintained
 - Protected against pressure drop by pressure-controlled non-return valve
- Excluding single-acting or double-acting control valve

Available on request

- Larger tank
- Other voltages / frequencies

Control valves	94
Accessories	95
Hydraulic hoses	98
Pressure gauges	101
Valve blocks 'FlowPanel'	104

specifications	06 S 6 SD	06 S 12 D	09 S 6 SD	09 S 12 D	09 S 25 D	09 S 50 D
art no	100.152.012	100.152.013	100.152.015	100.152.016	100.152.017	100.152.018
max. working pressure	bar/Mpa 720 / 72	720 / 72	720 / 72	720 / 72	720 / 72	720 / 72
capacity oil tank (effective)	cc 6000	12000	6000	12000	25000	50000
first stage output / min.	cc 600	600	900	900	900	900
first stage pressure range	0-720 / 0-72	0-720 / 0-72	0-720 / 0-72	0-720 / 0-72	0-720 / 0-72	0-720 / 0-72
operator type	bar/Mpa electric motor	electric motor	electric motor	electric motor	electric motor	electric motor
engine	230 VAC - 1.1 kW - 50 Hz - 1 Ph	230 VAC - 1.1 kW - 50 Hz - 1 Ph	230 VAC - 1.1 kW - 50 Hz - 1 Ph	230 VAC - 1.1 kW - 50 Hz - 1 Ph	230 VAC - 1.1 kW - 50 Hz - 1 Ph	230 VAC - 1.1 kW - 50 Hz - 1 Ph
weight, ready for use	kg 36.0	44.0	38.0	46.0	65.0	95.0
dimensions (LxWxH)	mm 400 x 300 x 411	400 x 300 x 541	400 x 300 x 541	500 x 380 x 541	500 x 380 x 541	500 x 380 x 676

specifications	12 S 6 SD	12 S 12 D	12 S 25 D	12 S 50 D
art no	100.152.020	100.152.021	100.152.022	100.152.023
max. working pressure	bar/Mpa 720 / 72	720 / 72	720 / 72	720 / 72
capacity oil tank (effective)	cc 6000	12000	25000	50000
first stage output / min.	cc 1200	1200	1200	1200
first stage pressure range	bar/Mpa 0-720 / 0-72	0-720 / 0-72	0-720 / 0-72	0-720 / 0-72
operator type	electric motor	electric motor	electric motor	electric motor
engine	230 VAC - 1.5 kW - 50 Hz - 1 Ph	230 VAC - 1.5 kW - 50 Hz - 1 Ph	230 VAC - 1.5 kW - 50 Hz - 1 Ph	230 VAC - 1.5 kW - 50 Hz - 1 Ph
weight, ready for use	kg 38.0	46.0	65.0	95.0
dimensions (LxWxH)	mm 400 x 300 x 411	400 x 320 x 541	500 x 380 x 541	500 x 380 x 676

VARI PUMPS | 230V - 2-stage



Features & benefits

- Safe
 - In case of a power failure, the oil pressure is maintained
 - Protected against pressure drop by pressure-controlled non-return valve
- Excluding single-acting or double-acting control valve

Available on request

- Larger tank
- Other voltages / frequencies

Control valves	94
Accessories	95
Hydraulic hoses	98
Pressure gauges	101
Valve blocks 'FlowPanel'	104

specifications	06 W 6 SD	06 W 12 D	09 S W SD	09 W 12 D	09 W 25 D	09 W 50 D
art no	100.152.025	100.152.026	100.152.028	100.152.029	100.152.030	100.152.031
max. working pressure	bar/Mpa 720 / 72	720 / 72	720 / 72	720 / 72	720 / 72	720 / 72
capacity oil tank (effective)	cc 6000	12000	6000	12000	25000	50000
first stage output / min.	cc 1600	1600	2500	2500	2500	2500
second stage output / min.	cc 600	600	900	900	900	900
first stage pressure range	bar/Mpa 0-200 / 0-20	0-200 / 0-20	0-200 / 0-20	0-200 / 0-20	0-200 / 0-20	0-200 / 0-20
second stage pressure range	bar/Mpa 200-720 / 0-72	200-720 / 0-72	200-720 / 0-72	200-720 / 0-72	200-720 / 0-72	200-720 / 0-72
operator type	electric motor	electric motor	electric motor	electric motor	electric motor	electric motor
engine	230 VAC - 1.1 kW - 50 Hz - 1 Ph	230 VAC - 1.1 kW - 50 Hz - 1 Ph	230 VAC - 1.1 kW - 50 Hz - 1 Ph	230 VAC - 1.1 kW - 50 Hz - 1 Ph	230 VAC - 1.1 kW - 50 Hz - 1 Ph	230 VAC - 1.1 kW - 50 Hz - 1 Ph
weight, ready for use	kg 38.0	46.0	40.0	48.0	67.0	96.0
dimensions (LxWxH)	mm 400 x 300 x 441	400 x 300 x 541	400 x 300 x 441	400 x 300 x 541	500 x 680 x 541	500 x 380 x 676

specifications	12 W 6 SD	12 W 12 D	12 W 25 D	12 W 50 D
art no	100.152.033	100.152.034	100.152.035	100.152.036
max. working pressure	bar/Mpa 720 / 72	720 / 72	720 / 72	720 / 72
capacity oil tank (effective)	cc 6000	12000	25000	50000
first stage output / min.	cc 3200	3200	3200	3200
second stage output / min.	cc 1200	1200	1200	1200
first stage pressure range	bar/Mpa 0-200 / 0-20	0-200 / 0-20	0-200 / 0-20	0-200 / 0-20
second stage pressure range	bar/Mpa 200-720 / 0-72	200-720 / 0-72	200-720 / 0-72	200-720 / 0-72
operator type	electric motor	electric motor	electric motor	electric motor
engine	230 VAC - 1.5 kW - 50 Hz - 1 Ph	230 VAC - 1.5 kW - 50 Hz - 1 Ph	230 VAC - 1.5 kW - 50 Hz - 1 Ph	230 VAC - 1.5 kW - 50 Hz - 1 Ph
weight, ready for use	kg 40.0	48.0	67.0	96.0
dimensions (LxWxH)	mm 400 x 300 x 411	400 x 300 x 541	500 x 380 x 541	500 x 380 x 676

VARI PUMPS | 400V - 1-stage



Features & benefits

- Safe
 - In case of a power failure, the oil pressure is maintained
 - Protected against pressure drop by pressure-controlled non-return valve
- Excluding single-acting or double-acting control valve

Available on request

- Larger tank
- Other voltages / frequencies

Control valves	94
Accessories	95
Hydraulic hoses	98
Pressure gauges	101
Valve blocks 'FlowPanel'	104

specifications	06 S 6 SE	06 S 12 E	09 S 6 SE	09 S 12 E	09 S 25 E	12 S 6 SE
art no	100.152.038	100.152.039	100.152.041	100.152.042	100.152.043	100.152.046
max. working pressure	bar/Mpa 720 / 72	720 / 72	720 / 72	720 / 72	720 / 72	720 / 72
capacity oil tank (effective)	cc 6000	12000	6000	12000	25000	6000
first stage output / min.	cc 600	600	900	900	900	1200
first stage pressure range	bar/Mpa 0-720 / 0-72	0-720 / 0-72	0-720 / 0-72	0-720 / 0-72	0-720 / 0-72	0-720 / 0-72
operator type	electric motor	electric motor	electric motor	electric motor	electric motor	electric motor
engine	400 VAC - 1.1 kW - 50 Hz - 3 Ph	400 VAC - 1.1 kW - 50 Hz - 3 Ph	400 VAC - 1.1 kW - 50 Hz - 3 Ph	400 VAC - 1.1 kW - 50 Hz - 3 Ph	400 VAC - 1.1 kW - 50 Hz - 3 Ph	400 VAC - 1.5 kW - 50 Hz - 3 Ph
weight, ready for use	kg 33.0	41.0	36.0	44.0	63.0	35.0
dimensions (LxWxH)	mm 400 x 300 x 441	400 x 300 x 541	400 x 300 x 441	500 x 380 x 541	500 x 380 x 541	400 x 300 x 441

specifications	12 S 12 E	12 S 25 E	12 S 50 E	18 S 12 E	18 S 25 E	12 S 6 SE
art no	100.152.047	100.152.048	100.152.049	100.152.050	100.152.051	100.152.052
max. working pressure	bar/Mpa 720 / 72	720 / 72	720 / 72	720 / 72	720 / 72	720 / 72
capacity oil tank (effective)	cc 6000	12000	6000	12000	25000	6000
first stage output / min.	cc 600	600	900	900	900	1200
first stage pressure range	bar/Mpa 0-720 / 0-72	0-720 / 0-72	0-720 / 0-72	0-720 / 0-72	0-720 / 0-72	0-720 / 0-72
operator type	electric motor	electric motor	electric motor	electric motor	electric motor	electric motor
engine	400 VAC - 1.5 kW - 50 Hz - 3 Ph	400 VAC - 1.5 kW - 50 Hz - 3 Ph	400 VAC - 1.5 kW - 50 Hz - 3 Ph	400 VAC - 2.2 kW - 50 Hz - 3 Ph	400 VAC - 2.2 kW - 50 Hz - 3 Ph	400 VAC - 2.2 kW - 50 Hz - 3 Ph
weight, ready for use	kg 43.0	62.0	92.0	45.0	64.0	94.0
dimensions (LxWxH)	mm 400 x 300 x 541	500 x 380 x 541	500 x 380 x 676	500 x 380 x 541	500 x 380 x 541	500 x 380 x 676

VARI PUMPS | 400V - 2-stage



Features & benefits

- Safe
 - In case of a power failure, the oil pressure is maintained
 - Protected against pressure drop by pressure-controlled non-return valve
- Excluding single-acting or double-acting control valve

Available on request

- Larger tank
- Other voltages / frequencies

Control valves	94
Accessories	95
Hydraulic hoses	98
Pressure gauges	101
Valve blocks 'FlowPanel'	104

specifications		06 W 6 SE	06 W 12 E	09 S W SE	09 W 12 E	09 W 25 E	12 W 6 SE
art no		100.152.054	100.152.055	100.152.057	100.152.058	100.152.059	100.152.062
max. working pressure	bar/Mpa	720 / 72	720 / 72	720 / 72	720 / 72	720 / 72	720 / 72
capacity oil tank (effective)	cc	6000	12000	6000	12000	25000	6000
first stage output / min.	cc	1600	1600	2500	2500	2500	3200
second stage output / min.	cc	600	600	900	900	900	1200
first stage pressure range	bar/Mpa	0-200 / 0-20	0-200 / 0-20	0-200 / 0-20	0-200 / 0-20	0-200 / 0-20	0-200 / 0-20
second stage pressure range	bar/Mpa	200-720 / 0-72	200-720 / 0-72	200-720 / 0-72	200-720 / 0-72	200-720 / 0-72	200-720 / 0-72
operator type		electric motor	electric motor	electric motor	electric motor	electric motor	electric motor
engine		400 VAC - 1.1 kW - 50 Hz - 3 Ph	400 VAC - 1.1 kW - 50 Hz - 3 Ph	400 VAC - 1.1 kW - 50 Hz - 3 Ph	400 VAC - 1.1 kW - 50 Hz - 3 Ph	400 VAC - 1.1 kW - 50 Hz - 3 Ph	400 VAC - 1.5 kW - 50 Hz - 3 Ph
weight, ready for use	kg	35.0	43.0	38.0	46.0	65.0	37.0
dimensions (LxWxH)	mm	400 x 300 x 441	400 x 300 x 541	400 x 300 x 441	400 x 300 x 541	500 x 380 x 541	400 x 300 x 441

specifications		12 W 12 E	12 W 25 E	12 W 50 E	18 W 12 E	18 W 25 E	18 W 50 E
art no		100.152.063	100.152.064	100.152.065	100.152.066	100.152.067	100.152.068
max. working pressure	bar/Mpa	720 / 72	720 / 72	720 / 72	720 / 72	720 / 72	720 / 72
capacity oil tank (effective)	cc	12000	25000	50000	12000	25000	50000
first stage output / min.	cc	3200	3200	3200	5000	5000	5000
second stage output / min.	cc	1200	1200	1200	1800	1800	1800
first stage pressure range	bar/Mpa	0-200 / 0-20	0-200 / 0-20	0-200 / 0-20	0-200 / 0-20	0-200 / 0-20	0-200 / 0-20
second stage pressure range	bar/Mpa	200-720 / 0-72	200-720 / 0-72	200-720 / 0-72	200-720 / 0-72	200-720 / 0-72	200-720 / 0-72
operator type		electric motor	electric motor	electric motor	electric motor	electric motor	electric motor
engine		400 VAC - 1.5 kW - 50 Hz - 3 Ph	400 VAC - 1.5 kW - 50 Hz - 3 Ph	400 VAC - 1.5 kW - 50 Hz - 3 Ph	400 VAC - 2.2 kW - 50 Hz - 3 Ph	400 VAC - 2.2 kW - 50 Hz - 3 Ph	400 VAC - 2.2 kW - 50 Hz - 3 Ph
weight, ready for use	kg	45.0	64.0	94.0	47.0	96.0	96.0
dimensions (LxWxH)	mm	400 x 300 x 541	500 x 380 x 541	500 x 380 x 676	400 x 300 x 541	500 x 380 x 676	500 x 380 x 676

VARI PUMPS | Twin - 400V - 1-stage



Features & benefits

- Pump with 2 separate outlets
- Safe
 - In case of a power failure, the oil pressure is maintained
 - Protected against pressure drop by pressure-controlled non-return valve
- Excluding single-acting or double-acting control valve

Available on request

- Larger tank
- Other voltages / frequencies

Control valves	94
Accessories	95
Hydraulic hoses	98
Pressure gauges	101
Valve blocks 'FlowPanel'	104

specifications		06 T 6 SE	06 T 12 E	09 T 12 E	09 T 25 E	09 T 50 E
art no		100.152.070	100.152.071	100.152.072	100.152.073	100.152.074
max. working pressure	bar/Mpa	720 / 72	720 / 72	720 / 72	720 / 72	720 / 72
capacity oil tank (effective)	cc	6000	12000	12000	25000	50000
first stage output / min.	cc	600	600	900	900	900
first stage pressure range	bar/Mpa	0-720 / 0-72	0-720 / 0-72	0-720 / 0-72	0-720 / 0-72	0-720 / 0-72
operator type		electric motor	electric motor	electric motor	electric motor	electric motor
engine		400 VAC - 1.5 KW - 50 HZ - 3 PH	400 VAC - 1.5 KW - 50 HZ - 3 PH	400 VAC - 2.2 KW - 50 HZ - 3 PH	400 VAC - 2.2 KW - 50 HZ - 3 PH	400 VAC - 2.2 KW - 50 HZ - 3 PH
weight, ready for use	kg	40.0	47.0	52.0	71.0	100.0
dimensions (LxWxH)	mm	400 x 300 x 441	400 x 300 x 541	400 x 300 x 541	500 x 380 x 541	500 x 380 x 676

VARI PUMPS | air - 1-stage - 8 bars



Features & benefits

- Safe
 - In case of a power failure, the oil pressure is maintained
 - Protected against pressure drop by pressure-controlled non-return valve
- Excluding single-acting or double-acting control valve

Available on request

- Larger tank
- Other voltages / frequencies

Control valves	94
Accessories	95
Hydraulic hoses	98
Pressure gauges	101
Valve blocks 'FlowPanel'	104

specifications		12 S 6 SA	12 S 12 A	12 S 25 A	12 S 50 A	18 S 12 A	18 S 25 A
art no		100.162.018	100.162.019	100.162.020	100.162.022	100.162.023	100.162.024
max. working pressure	bar/Mpa	720 / 72	720 / 72	720 / 72	720 / 72	720 / 72	720 / 72
capacity oil tank (effective)	cc	6000	12000	25000	50000	12000	25000
first stage output / min.	cc	1300	1300	1300	1300	2000	2000
first stage pressure range	bar/Mpa	0-720 / 0-72	0-720 / 0-72	0-720 / 0-72	0-720 / 0-72	0-720 / 0-72	0-720 / 0-72
operator type		air	air	air	air	air	air
engine		8 bars - 3.0 kW	8 bars - 3.0 kW	8 bars - 3.0 kW	8 bars - 3.0 kW	8 bars - 3.0 kW	8 bars - 3.0 kW
weight, ready for use	kg	33.0	41.0	60.0	89.0	42.0	62.0
dimensions (LxWxH)	mm	400 x 300 x 348	400 x 300 x 448	500 x 380 x 448	500 x 380 x 583	400 x 300 x 448	500 x 380 x 448

specifications		18 S 50 A
art no		100.162.025
max. working pressure	bar/Mpa	720 / 72
capacity oil tank (effective)	cc	50000
first stage output / min.	cc	2000
first stage pressure range	bar/Mpa	0-720 / 0-72
operator type		air
engine		8 bars - 3.0 kW
weight, ready for use	kg	91.0
dimensions (LxWxH)	mm	500 x 380 x 583

VARI PUMPS | air - 2-stage - 8 bars



Features & benefits

- Safe
 - In case of a power failure, the oil pressure is maintained
 - Protected against pressure drop by pressure-controlled non-return valve
- Excluding single-acting or double-acting control valve

Available on request

- Larger tank
- Other voltages / frequencies

Control valves	94
Accessories	95
Hydraulic hoses	98
Pressure gauges	101
Valve blocks 'FlowPanel'	104

specifications		12 W 6 SA	12 W 12 A	12 W 25 A	12 W 50 A	18 W 12 A	18 W 25 A
art no		100.162.027	100.162.028	100.162.029	100.162.030	100.162.032	100.162.033
max. working pressure	bar/Mpa	720 / 72	720 / 72	720 / 72	720 / 72	720 / 72	720 / 72
capacity oil tank (effective)	cc	6000	12000	25000	50000	12000	25000
first stage output / min.	cc	3600	3600	3600	3600	5700	5700
second stage output / min.	cc	1300	1300	1300	1300	2000	2000
first stage pressure range	bar/Mpa	0-200 / 0-20	0-200 / 0-20	0-200 / 0-20	0-200 / 0-20	0-200 / 0-20	0-200 / 0-20
second stage pressure range	bar/Mpa	200-720 / 20-72	200-720 / 20-72	200-720 / 20-72	200-720 / 20-72	200-720 / 20-72	200-720 / 20-72
operator type		air	air	air	air	air	air
engine		8 bars - 3.0 kW	8 bars - 3.0 kW	8 bars - 3.0 kW	8 bars - 3.0 kW	8 bars - 3.0 kW	8 bars - 3.0 kW
weight, ready for use	kg	35.0	43.0	62.0	91.0	44.0	63.0
dimensions (LxWxH)	mm	400 x 300 x 348	400 x 300 x 448	500 x 380 x 448	500 x 380 x 583	400 x 300 x 448	500 x 380 x 448

specifications		18 W 50 A
art no		100.162.034
max. working pressure	bar/Mpa	720 / 72
capacity oil tank (effective)	cc	50000
first stage output / min.	cc	5700
second stage output / min.	cc	2000
first stage pressure range	bar/Mpa	0-200 / 0-20
second stage pressure range	bar/Mpa	200-720 / 20-72
operator type		air
engine		8 bars - 3.0 kW
weight, ready for use	kg	93.0
dimensions (LxWxH)	mm	500 x 380 x 583

VARI PUMPS | petrol - 1-stage - 4 stroke



Features & benefits

- Safe
 - In case of a power failure, the oil pressure is maintained
 - Protected against pressure drop by pressure-controlled non-return valve
- Excluding single-acting or double-acting control valve

Available on request

- Larger tank

Control valves	94
Accessories	95
Hydraulic hoses	98
Pressure gauges	101
Valve blocks 'FlowPanel'	104

specifications		12 S 6 SP	12 S 12 P	12 S 25 P	12 S 50 P	18 S 12 P	18 S 25 P
art no		100.162.002	100.162.003	100.162.004	100.162.005	100.162.006	100.162.007
max. working pressure	bar/Mpa	720 / 72	720 / 72	720 / 72	720 / 72	720 / 72	720 / 72
capacity oil tank (effective)	cc	6000	12000	25000	50000	12000	25000
first stage output / min.	cc	1300	1300	1300	1300	2000	2000
first stage pressure range	bar/Mpa	0-720 / 0-72	0-720 / 0-72	0-720 / 0-72	0-720 / 0-72	0-720 / 0-72	0-720 / 0-72
operator type		petrol engine	petrol engine	petrol engine	petrol engine	petrol engine	petrol engine
engine		4 stroke - 4.2 HP - 3.1 kW	4 stroke - 4.2 HP - 3.1 kW	4 stroke - 4.2 HP - 3.1 kW	4 stroke - 4.2 HP - 3.1 kW	4 stroke - 4.2 HP - 3.1 kW	4 stroke - 4.2 HP - 3.1 kW
weight, ready for use	kg	35.0	43.0	62.0	91.0	44.0	64.0
dimensions (LxWxH)	mm	400 x 300 x 462	400 x 300 x 562	500 x 380 x 562	500 x 380 x 697	400 x 300 x 562	500 x 380 x 562

specifications		18 S 50 P
art no		100.162.008
max. working pressure	bar/Mpa	720 / 72
capacity oil tank (effective)	cc	50000
first stage output / min.	cc	2000
first stage pressure range	bar/Mpa	0-720 / 0-72
operator type		petrol engine
engine		4 stroke - 4.2 HP - 3.1 kW
weight, ready for use	kg	93.0
dimensions (LxWxH)	mm	400 x 380 x 697

VARI PUMPS | petrol - 2-stage - 4 stroke



Features & benefits

- Safe
 - In case of a power failure, the oil pressure is maintained
 - Protected against pressure drop by pressure-controlled non-return valve
- Excluding single-acting or double-acting control valve

Available on request

- Larger tank

Control valves	94
Accessories	95
Hydraulic hoses	98
Pressure gauges	101
Valve blocks 'FlowPanel'	104









specifications		12 W 6 SP	12 W 12 P	12 W 25 P	12 W 50 P	18 W 12 P	18 W 25 P
art no		100.162.010	100.162.011	100.162.012	100.162.013	100.162.014	100.162.015
max. working pressure	bar/Mpa	720 / 72	720 / 72	720 / 72	720 / 72	720 / 72	720 / 72
capacity oil tank (effective)	cc	6000	12000	25000	50000	12000	25000
first stage output / min.	cc	3600	3600	3600	3600	5700	5700
second stage output / min.	cc	1300	1300	1300	1300	2000	2000
first stage pressure range	bar/Mpa	0-200 / 0-20	0-200 / 0-20	0-200 / 0-20	0-200 / 0-20	0-200 / 0-20	0-200 / 0-20
second stage pressure range	bar/Mpa	200-720 / 20-72	200-720 / 20-72	200-720 / 20-72	200-720 / 20-72	200-720 / 20-72	200-720 / 20-72
operator type		petrol engine	petrol engine	petrol engine	petrol engine	petrol engine	petrol engine
engine		4 stroke - 4.2 HP - 3.1 kW	4 stroke - 4.2 HP - 3.1 kW	4 stroke - 4.2 HP - 3.1 kW	4 stroke - 4.2 HP - 3.1 kW	4 stroke - 4.2 HP - 3.1 kW	4 stroke - 4.2 HP - 3.1 kW
weight, ready for use	kg	37.0	45.0	64.0	93.0	46.0	65.0
dimensions (LxWxH)	mm	400 x 300 x 462	400 x 300 x 562	500 x 380 x 562	500 x 380 x 697	400 x 300 x 562	500 x 380 x 562

specifications		18 W 50 P
art no		100.162.016
max. working pressure	bar/Mpa	720 / 72
capacity oil tank (effective)	cc	50000
first stage output / min.	cc	5700
second stage output / min.	cc	2000
first stage pressure range	bar/Mpa	0-200 / 0-20
second stage pressure range	bar/Mpa	200-720 / 20-72
operator type		petrol engine
engine		4 stroke - 4.2 HP - 3.1 kW
weight, ready for use	kg	95.0
dimensions (LxWxH)	mm	500 x 380 x 697







CONTROL VALVES

hand pumps	hydraulic diagram	description	model	art no
		Control valve <ul style="list-style-type: none"> Suitable for double-acting tools Handle stops in each position With pressure controlled non-return valves for securing the load 4-way, 3-position Connection: 3/8" NPT female (2x) Max. working pressure: 720 bar 	VM 43 L	100.182.175
vari pumps				
		Control Valve <ul style="list-style-type: none"> Suitable for single-acting tools Handle stops in each position 3-way, 3-position Not in combination with a vari pump model (name) starting with 18 W Connection 3/8" NPT female thread (2x) Max. working pressure: 720 bar 	M 311	100.181.311
		Control Valve <ul style="list-style-type: none"> Suitable for double-acting tools Handle stops in each position With pressure-controlled non-return valves for securing the load 4-way, 3-position Connection: 3/8" NPT female (2x) Max. working pressure: 720 bar 	M 322	100.181.322
		Control Valve <ul style="list-style-type: none"> Suitable for double-acting tools Handle with dead man's function, automatically goes to "O" position With pressure-controlled non-return valves for securing the load 4-way, 3-position Connection: 3/8" NPT female (2x) Max. working pressure: 720 bar 	M 323	100.181.323
		Control Valve <ul style="list-style-type: none"> Suitable for double-acting tools Handle with dead man's function, automatically goes to "O" position With pressure-controlled non-return valves for securing the load 4-way, 3-position Connection: 3/8" NPT female (2x) Max. working pressure: 720 bar 	M 325	100.181.325
		Control Valve <ul style="list-style-type: none"> Only suitable in combination with EC-version Vari pumps. Contact our sales department for additional information Suitable for double-acting tools. Valve with electromagnetic control (24 VDC) With non-return valves for securing the load 3-position, 4-way valve Connection: 3/8" NPT female (2x) Remote control, art no 100.151.060 (to be ordered separately). 4 buttons (on, off, lift and lower) Max. working pressure: 720 bar 	M 326	100.182.321
		Single/double-acting valve <ul style="list-style-type: none"> For assembly on the vari pump underneath a double-acting valve (M 322, M 323, M324 or M 325) This valve makes it possible to drive both single and double acting tools with just one pump Switch with A + B function (double-acting) or A (single-acting) Max. working pressure: 720 bar 	M 304	100.172.051

ACCESSORIES

hand pumps	description	model	art no
	Foot plate set <ul style="list-style-type: none"> Suitable for PA 09 pumps 	-	100.182.218
	Foot plate set <ul style="list-style-type: none"> Suitable for PA 18/38 pumps 	-	100.182.217
	Foot plate set <ul style="list-style-type: none"> Suitable for PA 18/38 pumps including VM 43 L valve 	-	100.182.219
vari pumps			
	Connecting plate <ul style="list-style-type: none"> For remote or separately from the pump placing of the valves M 311, M 322, M 323, M 324 or M 325 (if necessary combined with pressure control valve M 303) Connection: 1/4" BSP female Max. working pressure: 720 bar 	M 302	100.181.302
	Connecting block <ul style="list-style-type: none"> For mounting couplers or hoses To be mounted on the pump when using connecting plate M 302 instead of control valve Provided with pressure relief valve Connection: 1/4" BSP female (2x), 3/8" NPT female (1x) Mounting of pressure gauge A 500 possible using nipple 100.581.104 Mounting pressure gauge A 150 possible using nipple 100.581.128 Max. working pressure: 720 bar 	M 301 B	100.182.088
	Pressure Control Valve <ul style="list-style-type: none"> For mounting onto the Pump or onto the connecting plate M 302 (below the connecting block M 301 or below the Valves M 311, M 322, M 323, M 324 or M 325) Pressure adjustable between 20 and 720 Bars Max. working pressure: 720 bar 	M 303	100.181.303
	Protection frame for 6, 12, 25 and 50 liter pumps	-	100.151.056
	Cover plate for protection frame	-	100.151.040
	Carrying handle set for 6 and 12 litre pumps	-	100.151.053

ACCESSORIES

vari pumps	description	model	art no
	Carrying handle set for 25 and 50 litre pumps	-	100.151.054
	Set of wheels for 25 and 50 litre pumps	-	100.151.039
	Carriage-frame for 6, 12, 25 and 50 litre pumps	-	100.151.038
	Silencer for air vari pumps	HSR 0.5 U	100.182.015
	Air treatment set for air Vari pump (separately delivered)	A 181 U	100.582.181
	Air treatment set for air vari pump (to be mounted)	-	100.161.003



SYSTEM COMPONENTS



HYDRAULIC HOSES | single hoses



Features & benefits

- Anti-kink springs on both sides
- 4:1 safety ratio

Available on request

- Different lengths
- Other colors

specifications		H 1 SO	H 2 SO	H 3 SO	H 4 SO	H 5 SO	H 6 SO
art no		100.571.101	100.571.102	100.571.103	100.571.104	100.571.105	100.571.106
max. working pressure	bar/Mpa	720 / 72	720 / 72	720 / 72	720 / 72	720 / 72	720 / 72
color		orange	orange	orange	orange	orange	orange
hose connection A		3/8" NPT male	3/8" NPT male	3/8" NPT male	3/8" NPT male	3/8" NPT male	3/8" NPT male
hose connection B		3/8" NPT male	3/8" NPT male	3/8" NPT male	3/8" NPT male	3/8" NPT male	3/8" NPT male
length	m	1	2	3	4	5	6

specifications		H 8 SO	H 10 SO	H 15 SO	H 20 SO
art no		100.571.108	100.571.110	100.571.115	100.571.120
max. working pressure	bar/Mpa	720 / 72	720 / 72	720 / 72	720 / 72
color		orange	orange	orange	orange
hose connection A		3/8" NPT male	3/8" NPT male	3/8" NPT male	3/8" NPT male
hose connection B		3/8" NPT male	3/8" NPT male	3/8" NPT male	3/8" NPT male
length	m	8	10	15	20

HYDRAULIC HOSES | standard hoses



Features & benefits

- Anti-kink springs on both sides
- 4:1 safety ratio

Available on request

- Different lengths
- Other colors

specifications		H 1 SOU	H 2 SOU	H 3 SOU	H 4 SOU	H 5 SOU	H 6 SOU
art no		100.572.101	100.572.102	100.572.103	100.572.104	100.572.105	100.572.106
max. working pressure	bar/Mpa	720 / 72	720 / 72	720 / 72	720 / 72	720 / 72	720 / 72
color		orange	orange	orange	orange	orange	orange
hose connection A		3/8" NPT male	3/8" NPT male	3/8" NPT male	3/8" NPT male	3/8" NPT male	3/8" NPT male
hose connection B		A 119	A 119	A 119	A 119	A 119	A 119
length	m	1	2	3	4	5	6

specifications		H 8 SOU	H 10 SOU	H 15 SOU	H 20 SOU
art no		100.572.108	100.572.110	100.572.115	100.572.120
max. working pressure	bar/Mpa	720 / 72	720 / 72	720 / 72	720 / 72
color		orange	orange	orange	orange
hose connection A		3/8" NPT male	3/8" NPT male	3/8" NPT male	3/8" NPT male
hose connection B		A 119	A 119	A 119	A 119
length	m	8	10	15	20

HYDRAULIC HOSES | extension hoses



Features & benefits

- Anti-kink springs on both sides
- 4:1 safety ratio

Available on request

- Different lengths
- Other colors

specifications		VL 1 SOU	VL 2 SOU	VL 3 SOU	VL 5 SOU	VL 10 SOU	VL 15 SOU
art no		100.572.301	100.572.302	100.570.294	100.572.305	100.572.310	100.572.315
max. working pressure	bar/Mpa	720 / 72	720 / 72	720 / 72	720 / 72	720 / 72	720 / 72
color		orange	orange	orange	orange	orange	orange
hose connection A		A 119	A 119	A 119	A 119	A 119	A 119
hose connection B		A 118	A 118	A 118	A 118	A 118	A 118
length	m	1	2	3	5	10	15

specifications		VL 20 SOU
art no		100.572.320
max. working pressure	bar/Mpa	720 / 72
color		orange
hose connection A		A 119
hose connection B		A 118
length	m	20

HYDRAULIC HOSES | non-conductive single hoses



Features & benefits











- Anti-kink protection on both sides
- 4:1 safety ratio

Available on request

- Different lengths
- Other colors

specifications		H 2 MNC	H 5 MNC	H 10 MNC
art no		100.570.251	100.999.266	100.570.252
max. working pressure	bar/Mpa	720 / 72	720 / 72	720 / 72
color		orange	orange	orange
hose connection A		3/8" NPT male	3/8" NPT male	3/8" NPT male
hose connection B		3/8" NPT male	3/8" NPT male	3/8" NPT male
length	m	2	5	10

COUPLERS

couplers	description	model	art no
	High Flow Coupler, female, including steel dust cap • Connection: 3/8" NPT, male • Fits: A 119 • Max. working pressure: 720 bar	A 118	100.181.118
	High Flow Coupler, male, including steel dust cap • Connection: 3/8" NPT, female • Fits: A 118, A 134 N and A 418 • Max. working pressure: 720 bar	A 119	100.181.119
	High Flow Coupler, female, like A 118, with built-in pressure relief Valve • Adjusted to ca. 750 Bars • Connection: 3/8" NPT, male • Fits: A 119 • Max. working pressure: 720 bar	A 418	100.181.418
	High flow coupler, female, like A 118, with built-in-non-return valve • Suitable for hose rupture security • Not to be used with double-acting systems • Connection: 3/8" NPT, male • Fits: A 119 • Max. working pressure: 720 bar	A 134 N	100.181.434
	High Flow Coupler, female, including dust cap • Connection: 3/8" NPT, male • Fits: A 119 SS • Material: stainless steel AISI 316 • This coupler cannot be assembled on aluminium parts because of contact corrosion! • Max. working pressure: 720 bar	A 118 SS	100.002.499
	High Flow Coupler, male, including dust cap • Connection: 3/8" NPT, female • Fits: A 118 SS • Material: stainless steel AISI 316 • This coupler cannot be assembled on aluminium parts because of contact corrosion! • Max. working pressure: 720 bar	A 119 SS	100.002.500
	Loose steel dust cap • With fixing thread • Fits: A 118 • Max. working pressure: 720 bar	A 118 SK	100.181.828
	Loose steel dust cap • With fixing thread • Fits: A 119 • Max. working pressure: 720 bar	A 119 SK	100.181.829
	Loose dust cap • With fixing thread • Fits: A 118 SS • Material: stainless steel AISI 316 • Max. working pressure: 720 bar	A 118 SK SS	100.002.503
	Loose dust cap • With fixing thread • Fits: A 119 SS • Material: stainless steel AISI 316 • Max. working pressure: 720 bar	A 119 SK SS	100.002.504

COUPLERS

couplers	description	model	art no
	Relief valve • For reducing any remnant pressure • Suitable for: A 118 • Max. working pressure: 720 bar	A 118	100.181.840
	Relief valve • For reducing any remnant pressure • Suitable for: A 119 • Max. working pressure: 720 bar	A 119	100.181.841

PRESSURE GAUGES | scale division in ton







Features & benefits

- Pointer damped with glycerine
- Stainless steel
- Housing Ø 100 mm
- Connection: 1/2" NPT male



specifications	A 501	A 502	A 503	A 504	A 505	A 506
art no	100.582.501	100.582.502	100.582.503	100.582.504	100.582.505	100.582.506
1st scale range	t	5	25	52	105	210
2nd scale range	t	11	33	77	160	382
3rd scale range	t	21	51			
1st scale division per mark	kg	100.0	500.0	1000.0	2000.0	5000.0
2nd scale division per mark	kg	200.0	500.0	1000.0	2000.0	5000.0
3rd scale division per mark	kg	500.0	1000.0			
connection	1/2" NPT male	1/2" NPT male	1/2" NPT male	1/2" NPT male	1/2" NPT male	1/2" NPT male
material	stainless steel	stainless steel	stainless steel	stainless steel	stainless steel	stainless steel
housing diameter	mm	100	100	100	100	100

specifications	A 507	A 508	A 509	A 510
art no	100.582.507	100.582.508	100.582.509	100.582.510
1st scale range	t	6	30	63
2nd scale range	t	12	47	104
3rd scale range	t	23	63	
4th scale range	t		113	
1st scale division per mark	kg	100.0	500.0	1000.0
2nd scale division per mark	kg	200.0	1000.0	2000.0
3rd scale division per mark	kg	500.0	1000.0	
4th scale division per mark	kg		2000.0	
connection	1/2" NPT male	1/2" NPT male	1/2" NPT male	1/2" NPT male
material	stainless steel	stainless steel	stainless steel	stainless steel
housing diameter	mm	100	100	100





PRESSURE GAUGES | scale division in bars

pressure gauges	description	model	art no
	Universal pressure gauge <ul style="list-style-type: none"> • 0 - 720 bars • Pointer damped with glycerine • Stainless steel • Housing Ø 100 mm • Connection: ½" NPT male 	A 500	100.582.500
	Rubber protection cover <ul style="list-style-type: none"> • Suitable for Ø 100 mm pressure gauges 	-	350.581.160
	Pressure gauge <ul style="list-style-type: none"> • 0 - 720 bars • Pointer damped with glycerine • Stainless steel • Housing Ø 60 mm • Connection: ¼" NPT male 	A 150	100.581.036
	Rubber protection cover <ul style="list-style-type: none"> • Suitable for Ø 60 mm pressure gauges 	-	350.581.152
	Pressure gauge digital <ul style="list-style-type: none"> • 0 - 1000 Bars • Peak pressure memory • Connection: ¼" BSP male 	-	150.581.091

PRESSURE GAUGES | adaptors

pressure gauges	description	model	art no
	Pressure gauge connecting block for vari pumps <ul style="list-style-type: none"> • Suitable for single-acting control Valve M 311 • Provided with: 1 x 3/8" NPT female, 1 x 3/8" NPT male and ½" NPT female for pressure gauge • Pressure gauge can be placed in an angle of 45° using Elbow, art no 100.581.240 • Max. working pressure: 720 bar 	A 108	100.181.108
	Pressure gauge connecting block for vari pumps <ul style="list-style-type: none"> • Suitable for double-acting control valves M 322, M 323, M 324 and M 325 • Supplies pressure to port A or B, dependent on which is highest • Provided with: 1 x ½" NPT female • Max. working pressure: 720 bar 	M 308	100.182.308

PRESSURE GAUGES | sets

pressure gauges	description	model	art no
	Pressure gauge set PA 04/09 pump <ul style="list-style-type: none"> • 0-720 bars • Pointer damped with glycerine • Stainless steel • Housing Ø 63 mm • Including rubber protection cover • Connection: ¼" NPT male 	-	100.182.213
	Pressure gauge set PA *8 pumps <ul style="list-style-type: none"> • 0-720 bars • Pointer damped with glycerine • Stainless steel • Housing Ø 63 mm • Including rubber protection cover • Connection: ¼" NPT male 	-	100.182.214
	Pressure gauge set PA pumps <ul style="list-style-type: none"> • 0-720 bars • Pointer damped with glycerine • Stainless steel • Housing Ø 100 mm • Including rubber protection cover • Connection: 1x 3/8" NPT female and 1x 3/8" NPT male 	-	100.182.215
	Pressure gauge set VM 43 L valve <ul style="list-style-type: none"> • 0-720 bars • Pointer damped with glycerine • Stainless steel • Housing Ø 63 mm • Including rubber protection cover • Connection: ¼" NPT male 	-	100.182.216
	Plug-in type gauge set <ul style="list-style-type: none"> • 0-720 bars • Connection: couplers A 118 - A 119 	A 111 U	100.582.111



VALVE BLOCKS 'FLOWPANEL' | single-acting

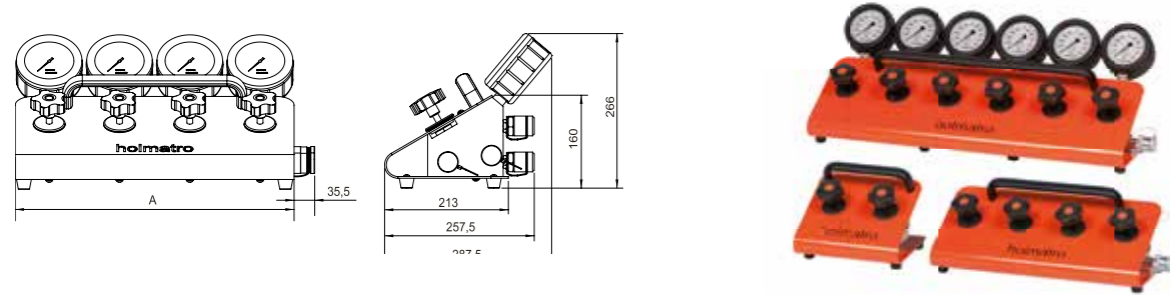

Features & benefits

- Excellent control over your load; extremely accurate regulation of oil flow under high pressure
- Safe; stable construction
- Ergonomic
 - Regulator valves with comfortable rotary knobs
 - Pressure gauges that are easy to read
 - Installation on vari pump is possible for comfortable working position
 - Carry-handle positioned above centre of gravity

Hydraulic hoses	98
Couplers	100
Pressure gauges	101

Available on request

- Can be mounted on the protection frame of the Vari pumps

specifications		HMS 2 A	HMS 2 B	HMS 2 C	HMS 4 A	HMS 4 B	HMS 4 C
art no		100.172.048	100.172.049	100.172.050	10.172.045	100.172.046	100.172.047
max. working pressure	bar/Mpa	720 / 72	720 / 72	720 / 72	720 / 72	720 / 72	720 / 72
number of outlet ports		2	2	2	4	4	4
couplers			yes	yes		yes	yes
pressure gauges				yes			yes
weight, ready for use	kg	6.2	7.1	9.0	12.5	13.9	17.8
dimension A	mm	238	238	238	480	480	480

specifications		HMS 6 A	HMS 6 B	HMS 6 C
art no		100.172.052	100.172.053	100.172.054
max. working pressure	bar/Mpa	720 / 72	720 / 72	720 / 72
number of outlet ports		6	6	6
couplers			yes	yes
pressure gauges				yes
weight, ready for use	kg	18.5	20.5	26.6
dimension A	mm	722	722	722

VALVE BLOCKS 'FLOWPANEL' | double-acting

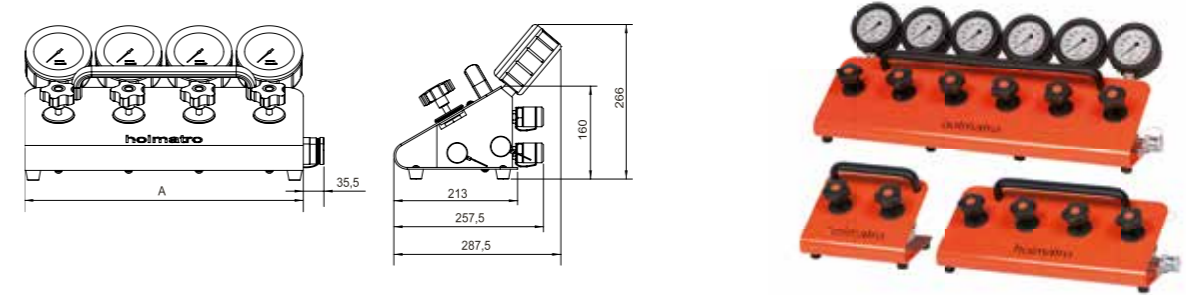

Features & benefits

- Excellent control over your load; extremely accurate regulation of oil flow under high pressure
- Safe; stable construction
- Ergonomic
 - Regulator valves with comfortable rotary knobs
 - Pressure gauges that are easy to read
 - Installation on vari pump is possible for comfortable working position
 - Carry-handle positioned above centre of gravity

Hydraulic hoses	98
Couplers	100
Pressure gauges	101

Available on request

- Can be mounted on the protection frame of the Vari pumps











specifications		HMD 2 A	HMD 2 B	HMD 2 C	HMD 4 A	HMD 4 B	HMD 4 C
art no		100.172.042	100.172.043	100.172.044	10.172.039	100.172.040	100.172.041
max. working pressure	bar/Mpa	720 / 72	720 / 72	720 / 72	720 / 72	720 / 72	720 / 72
number of outlet ports		2	2	2	4	4	4
couplers			yes	yes		yes	yes
pressure gauges				yes			yes
weight, ready for use	kg	7.2	8.1	10.0	14.2	15.6	19.7
dimension A	mm	238	238	238	480	480	480







specifications		HMD 6 A	HMD 6 B	HMD 6 C
art no		100.172.055	100.172.056	100.172.057
max. working pressure	bar/Mpa	720 / 72	720 / 72	720 / 72
number of outlet ports		6	6	6
couplers			yes	yes
pressure gauges				yes
weight, ready for use	kg	21.0	23.0	29.1
dimension A	mm	722	722	722

VALVES

valves	hydraulic diagram	description	model	art no
		Needle valve A 109 N • For accurate control of the oil flow, also under maximum pressure • Connection: 3/8" NPT female (2x) • Max. working pressure: 720 bar	A 109 N	100.581.609
		Ball valve • Very suitable for quick shut-off valve (open-close) • Can be operated under maximum pressure • Connection: 3/8" NPT female (2x) • Max. working pressure: 720 bar	A 195	100.581.200
		Needle valve A 130 • For accurate control of the oil flow, also under maximum pressure • Connection: 3/8" NPT male and 3/8" NPT female • Max. working pressure: 720 bar	A 130	100.181.130
		Breaking safety (load security) valve • Protects against sudden pressure drop in the supply pipe, for example in case of hose rupture • To be mounted between pump and cylinder as close to the cylinder as possible • Provided with pressure relief valve, set at 830 bars • While pumping: valve closed, safety valve active • For relief: open valve, safety valve not active • Connection: 3/8" NPT female and 3/8" NPT male • Max. working pressure: 720 bar	A 110	100.181.110
		High flow coupler, female, like A 118, with built-in-non-return valve • Suitable for hose rupture security • Not to be used with double-acting systems • Connection: 3/8" NPT, male • Fits: A 119 • Max. working pressure: 720 bar	A 134 N	100.181.434
		Non-Return Valve • Spring-loaded • Connection: 3/8" NPT male (2x) • Max. working pressure: 720 bar	A 209	100.581.209
		Pressure relief valve • Set to 750 bars • Connection: 1x 3/8" NPT female and 1x 3/8" NPT male • Max. working pressure: 720 bar	A 135	100.181.135

ACCESSORIES HYDRAULICS

accessories hydraulics	description	model	art no
	45° elbow with 1x 1/2" NPT female and 1x 1/2" NPT male • Max. working pressure: 720 bar	-	100.581.240
	Adjustable pin key, complete with 4 pairs of exchangeable pins • Max. working pressure: 720 bar	-	100.581.132
	Cross piece with 4x 3/8" NPT female • Max. working pressure: 720 bar	-	100.581.139
	T-piece with 3x 3/8" NPT female • Max. working pressure: 720 bar	-	100.001.010
	Y-piece with 3x 3/8" NPT female • Max. working pressure: 720 bar	-	100.182.104
	90° Elbow with 1x 3/8" NPT female and 1x 3/8" NPT male • Max. working pressure: 720 bar	-	100.581.113
	90° Elbow with 2x 3/8" NPT male • Max. working pressure: 720 bar	-	100.581.213
	45° Elbow with 1x 3/8" NPT female and 1x 3/8" NPT male • Max. working pressure: 720 bar	-	100.581.114
	90° bend with 1x 1/4" BSP female swivel Nut and 1x 1/4" BSP male • Max. working pressure: 720 bar	-	150.581.219
	Straight tube connector for 12 mm tube with 3/8" NPT male • Max. working pressure: 720 bar	-	100.581.136

accessories hydraulics	description	model	art no
	90° pipe connector for 12 mm tube with 3/8" NPT male • Max. working pressure: 720 bar	-	100.581.137
	Plug with 3/8" NPT • Max. working pressure: 720 bar	-	100.581.105
	Sealing ring for M12 • Max. working pressure: 720 bar	-	190.593.275
	Sealing ring for 1/4" BSP • Max. working pressure: 720 bar	-	150.581.230
	Sealing ring for M14 • Max. working pressure: 720 bar	-	190.593.075
	Sealing ring for M18 • Max. working pressure: 720 bar	-	100.581.158
	Manifold with 5 interconnected ports with 3/8" NPT female • Max. working pressure: 720 bar	A 125	100.181.125

ASSEMBLY MATERIALS | connection socket

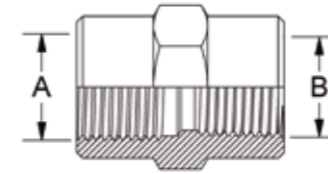

specifications	connection socket	connection socket	connection socket	connection socket	connection socket
art no	100.581.238	150.581.228	100.181.227	100.581.102	100.181.228
max. working pressure	bar/Mpa	720 / 72	720 / 72	720 / 72	720 / 72
thread A	1/4" NPT	1/4" NPT	1/4" BSP	3/8" NPT	3/8" NPT
thread B	1/4" NPT	1/4" BSP	M18 x 1.5	3/8" NPT	M18 x 1.5

ASSEMBLY MATERIALS | reducing bushing

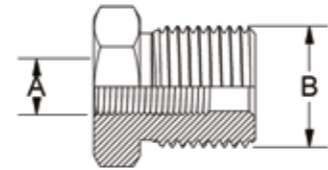

specifications	reducing bushing	reducing bushing	reducing bushing	reducing bushing
art no	100.581.128	100.581.103	100.581.133	150.581.085
max. working pressure	bar/Mpa	720 / 72	720 / 72	720 / 72
thread A	1/4" NPT	3/8" NPT	3/8" NPT	1/8" BSP
thread B	3/8" NPT	1/2" NPT	3/4" NPT	1/2" BSP



ASSEMBLY MATERIALS | nipple

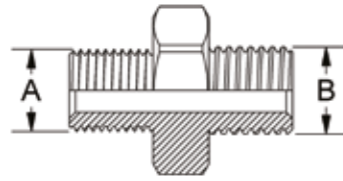

specifications	nipple	nipple	nipple	nipple	nipple	nipple
art no	110.013.004	150.581.227	110.013.044	100.581.211	100.181.156	150.581.216
max. working pressure	bar/Mpa	720 / 72	720 / 72	720 / 72	720 / 72	720 / 72
thread A		1/8" NPT	1/4" NPT	1/4" BSP	1/4" BSP	1/4" BSP
thread B		3/8" NPT	1/4" BSP	M12 x 1.75	M14 x 1.5	M14 x 2

specifications	nipple	nipple	nipple	nipple	nipple	nipple
art no	150.581.218	100.581.101	100.181.151	150.581.088	110.013.005	150.581.244
max. working pressure	bar/Mpa	720 / 72	720 / 72	720 / 72	720 / 72	720 / 72
thread A		1/4" BSP	3/8" NPT	3/8" NPT	1/2" BSP	1/4" NPT
thread B		3/8" NPT	3/8" NPT	M14 x 2	1/2" NPT	M10 x 1

specifications	nipple	nipple
art no	150.581.087	100.581.239
max. working pressure	bar/Mpa	720 / 72
thread A		1/2" BSP
thread B		3/8" NPT

ASSEMBLY MATERIALS | connector

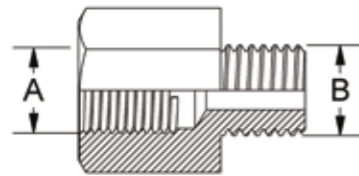

specifications	connector	connector	connector	connector	connector	connector
art no	100.181.223	100.581.235	100.181.159	150.581.217	100.581.107	100.181.153
max. working pressure	bar/Mpa	720 / 72	720 / 72	720 / 72	720 / 72	720 / 72
thread A		1/4" BSP	1/4" BSP	1/4" BSP	3/8" NPT	3/8" NPT
thread B		1/4" NPT	3/8" BSP	M14 x 2	1/4" NPT	M14 x 2





specifications	connector	connector	connector	connector	connector	connector
art no	100.581.104	100.181.129	150.581.058	100.181.154	100.181.157	100.181.047
max. working pressure	bar/Mpa	720 / 72	720 / 72	720 / 72	720 / 72	720 / 72
thread A		1/2" NPT	M14 x 1.5	M14 x 1.5	M18 x 1.5	1/4" NPT
thread B		3/8" NPT	3/8" NPT	1/4" BSP	3/8" NPT	M10 x 1

specifications	connector
art no	150.000.398
max. working pressure	bar/Mpa
thread A	1/4" BSP
thread B	3/8" NPT

OILS

oils	description	model	art no
	Hydraulic oil ECO Power, DIN 51524.3 HVLP, bottle 1 litre <ul style="list-style-type: none"> Fully mineral oil Optimum lubricating properties Excellent protection against wear and corrosion Up to 3x longer service life than the leading hydraulic oils Standard oil for all Holmatro motor pumps 	ISO VG 36 - 1L	180.000.857
	Hydraulic oil ECO Power, DIN 51524.3 HVLP, bottle 5 litres <ul style="list-style-type: none"> Fully mineral oil Optimum lubricating properties Excellent protection against wear and corrosion Up to 3x longer service life than the leading hydraulic oils Standard oil for all Holmatro motor pumps 	ISO VG 36 - 5L	180.000.815
	Hydraulic oil ECO Power, DIN 51524.3 HVLP, drum 60 litres <ul style="list-style-type: none"> Fully mineral oil Optimum lubricating properties Excellent protection against wear and corrosion Up to 3x longer service life than the leading hydraulic oils Standard oil for all Holmatro motor pumps 	ISO VG 36 - 60L	130.103.025
	Hydraulic oil ECO Power, DIN 51524.3 HVLP, drum 208 litres <ul style="list-style-type: none"> Fully mineral oil Optimum lubricating properties Excellent protection against wear and corrosion Up to 3x longer service life than the leading hydraulic oils Standard oil for all Holmatro motor pumps 	ISO VG 36 - 208L	180.001.543
	Hydraulic oil ECO Power, DIN 51524.3 HVLP, bottle 1 litre <ul style="list-style-type: none"> Fully mineral oil Optimum lubricating properties Excellent protection against wear and corrosion Up to 3x longer service life than the leading hydraulic oils Standard oil for all Holmatro tools and hand pumps 	ISO VG 15 - 1L	100.581.051
	Hydraulic OIL ECO Power, DIN 512524.3 HVLP, bottle of 5 litres <ul style="list-style-type: none"> Fully mineral oil Optimum lubricating properties Excellent protection against wear and corrosion Up to 3x longer service life than the leading hydraulic oils Standard oil for all Holmatro tools and hand pumps 	ISO VG 15 - 5L	100.581.055
	Hydraulic OIL ECO Power, DIN 512524.3 HVLP, drum of 208 litres <ul style="list-style-type: none"> Fully mineral oil Optimum lubricating properties Excellent protection against wear and corrosion Up to 3x longer service life than the leading hydraulic oils Standard oil for all Holmatro tools and hand pumps 	ISO VG 15 - 208L	180.000.910
	Motor oil, API SJ/CH-4, bottle 0.6 litre <ul style="list-style-type: none"> Very good detergent and dispersant Optimum protection against wear, corrosion and foam High and stable viscosity Low sulphate ash content 	0 W 30	150.581.103

LUBRICANTS

lubricants	description	model	art no
	Molykote® grease paste • For mounting and lapping of metal parts • Tube 100 g	-	100.581.081
	High-quality Molykote® grease • For metal / metal combinations at slow to fast movements with medium to heavy load • Cartridge 400 g	-	100.581.082
	Brake cleaner (degreasant) Motip® • For cleaning and pre-treatment of surfaces • Spray can 500 ml	-	890.000.025
	Teflon lubricating oil Sir John® • High-quality lubricant and maintenance oil • Spray can 400 ml	-	150.581.095
	Anti-friction coating Bel Ray® • Dry spray coating for protection under dusty, dirty and abrasive conditions • Spray can 400 ml	-	150.581.093



TENSIONING HYDRAULICS

STUD TENSION CYLINDERS | selection chart

6-step plan for selection of stud tension cylinders

Step 1
Cylinder selection by bolt diameter.

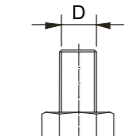

stud tension cylinder	bolt diameter - through to	
	mm	inch
HHX 14	M20 - M22	3/4 - 7/8
HHX 22	M24 - M28	1 - 1 1/8
HHX 35	M30 - M34	1 1/4 - 1 3/8
HTX 50	M36 - M40	1 1/2 - 1 5/8
HTX 70	M42 - M46	1 3/4 - 1 7/8
HTX 100	M48 - M56	2 - 2 1/4
HTX 150	M60 - M68	2 1/2 - 2 3/4
HTX 180	M72 - M76	2 3/4 - 3
HTX 220	M76 - M80	3 - 3 1/4
HTX 260	M80 - M85	3 1/4 - 3 1/2

Step 2
Check height of threaded rod.

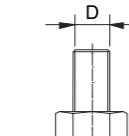

stud tension cylinder	min. height of threaded rod above flange
	mm
HHX 14	28 + D
HHX 22	30 + D
HHX 35	35 + D
HTX 50	55 + D
HTX 70	65 + D
HTX 100	70 + D
HTX 150	90 + D
HTX 180	90 + D
HTX 220	85 + D
HTX 260	105 + D

Step 3
Check stud tension force.

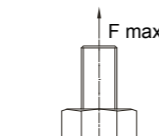

stud tension cylinder	max. pulling force	
	ton	kN
HHX 14	14	140
HHX 22	22	221
HHX 35	35	352
HTX 50	50	501
HTX 70	70	702
HTX 100	100	999
HTX 150	150	1500
HTX 180	180	1803
HTX 220	220	2174
HTX 260	260	2601

Step 4
Check cylinder dimensions

See table stud tension cylinders (pages 115-117)

Step 5
Assembly of a stud tension cylinder.

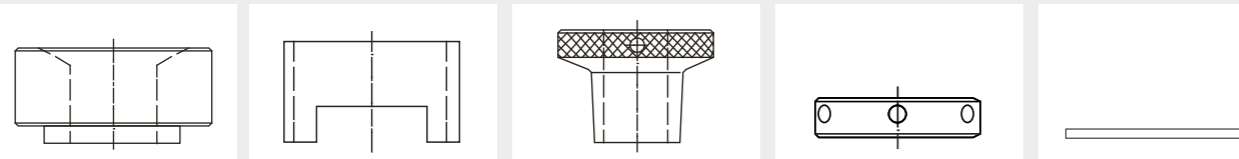

stud tension cylinder		cylinder bridge		pulling nut		nut socket		tommy bar	
model	art no	model	art no	model	model	art no	Ø mm	art no	Ø mm
HHX 14	110.011.101	-	-	PN 14 + THREAD	NS 14 + SLW	110.181.090	6	110.181.090	6
HHX 22	110.011.002	-	-	PN 22 + THREAD	NS 22 + SLW	110.181.091	8	110.181.091	8
HHX 35	110.011.012	-	-	PN 35 + THREAD	NS 35 + SLW	110.181.091	8	110.181.091	8
HTX 50	110.011.121	BR 50	110.181.151	PN 50 + THREAD	NS 50 + SLW	110.181.091	8	110.181.091	8
HTX 70	110.011.131	BR 70	110.181.152	PN 70 + THREAD	NS 70 + SLW	110.181.092	10	110.181.092	10
HTX 100	110.011.141	BR 100	110.181.153	PN 100 + THREAD	NS 100 + SLW	110.181.092	10	110.181.092	10
HTX 150	110.011.151	BR 150	110.181.154	PN 150 + THREAD	NS 150 + SLW	110.181.093	12	110.181.093	12
HTX 180	110.011.161	BR 180	110.181.155	PN 180 + THREAD	NS 180 + SLW	110.181.093	12	110.181.093	12
HTX 220	110.011.171	BR 220	110.181.156	PN 220 + THREAD	NS 220 + SLW	110.181.093	12	110.181.093	12
HTX 260	110.011.181	BR 260	110.181.157	PN 260 + THREAD	NS 260 + SLW	110.181.094	16	110.181.094	16

THREAD = thread type x pitch (e.g. M36 x 4)
SLW = key size of nut (e.g. SLW 50)

Step 6
Additional items for connection or operation, based on the n-number of cylinders that are used in a coupled situation.

no	description	mention with order
n	Connection pieces	Connection pieces A 240 U, art no 110.582.240
n-1	Hoses between the cylinders	E.g. hose, model X 1.2 MU, art no 110.572.012 (see 'Hydraulic hoses', page 119)
2	Hoses to pump and pressure gauge	E.g. hose, model X 3 MU, art no 110.572.030 (see 'Hydraulic hoses', page 119)
1	Pump (hand or foot operated)	E.g. hand pump, model PAX 18 H 2, art no 110.142.005 (see 'Pump', page 118)
1	Pressure gauge	Pressure gauge A 148 U, art no 110.582.348 (see 'Couplers and accessories', page 120)

Recommendation with respect to the number of cylinders to be used: the best result is achieved with a 100% occupation. This means that every threaded rod is fitted with a stud tension cylinder and is tensioned simultaneously. A lower occupation level is possible. However, you must take account of the fact that the force is increased evenly and in steps along the contour of the object to be tensioned.

STUD TENSION CYLINDERS | including cylinder bridge

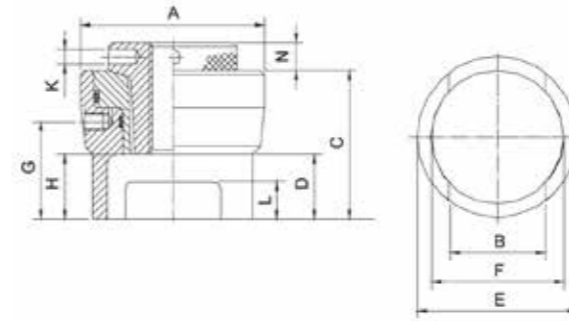

Features & benefits

- HHX-cylinders standard provided with cylinder seat
- Compact and lightweight
- Usable in all positions
- High-quality and refined chrome nickel steel
- Automatically locking quick coupler
- Pulling nut is manufactured in conformity with customer specifications based on exact thread and bolt dimensions
- Nut socket is manufactured in conformity with customer specifications based on exact key size of the nut
- Advantages compared with traditional stud tensioning methods
 - The effects of frictions are negligible; higher accuracy when tightening the bolt
 - Time-saving; several cylinders can be coupled for simultaneously tensioning several bolt connections

Accessories

- Pulling nut
- Nut socket
- Tommy bar

Pump	118
Hydraulic hoses	119
Couplers and accessories	120

Available on request

- Stud tension cylinders manufactured in conformity with customer specifications
- Extended pulling nut
- Heightened or lowered bridges (HTX)

specifications		HHX 14	HHX 22	HHX 85
art no		110.011.101	110.011.002	110.011.012
max. working pressure	bar/Mpa	1000 / 100	1000 / 100	1000 / 100
stroke	mm	8	8	8
min. reach bolt		M20	M24	M30
max. reach bolt		M22	M28	M34
capacity	kN/t	140 / 14.3	221 / 22.5	352 / 35.9
required oil content (effective)	cc	11.2	17.7	28.2
weight, ready for use	kg	1.4	2.1	2.5
dimension A	mm	70	90	100
dimension B	mm	36	47	52
dimension C	mm	85	80	80
dimension D	mm	28	30	35
dimension E	mm	56	76	87
dimension F	mm	47	60	72
dimension G	mm	58	53	53
dimension H	mm	28	30	35
dimension K	mm	6	8	8
dimension L	mm	20	20	20
dimension N	mm	15	15	15

STUD TENSION CYLINDERS | excluding cylinder bridge

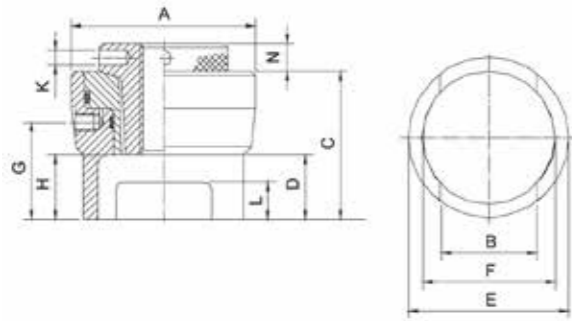

Features & benefits

- Compact and lightweight
- Usable in all positions
- High-quality and refined chrome nickel steel
- Automatically locking quick coupler
- Pulling nut is manufactured in conformity with customer specifications based on exact thread and bolt dimensions
- Nut socket is manufactured in conformity with customer specifications based on exact key size of the nut
- Advantages compared with traditional stud tensioning methods
 - The effects of frictions are negligible; higher accuracy when tightening the bolt
 - Time-saving; several cylinders can be coupled for simultaneously tensioning several bolt connections

Accessories

- Cylinder bridge
- Pulling nut
- Nut socket
- Tommy bar

Pump	118
Hydraulic hoses	119
Couplers and accessories	120

Available on request

- Stud tension cylinders manufactured in conformity with customer specifications
- Extended pulling nut
- Heightened or lowered bridges (HTX)

specifications	HTX 80	
art no	110.011.181	
max. working pressure	bar/Mpa	1000 / 100
stroke	mm	12
min. reach bolt	M80	
max. reach bolt	M85	
capacity	kN/t	2600 / 265.1
required oil content (effective)	cc	312
weight, ready for use	kg	28.0
dimension A	mm	270
dimension B	mm	99
dimension C	mm	195
dimension D	mm	115
dimension E	mm	228
dimension F	mm	170
dimension G	mm	128
dimension H	mm	105
dimension K	mm	16
dimension L	mm	40
dimension N	mm	35

specifications		HTX 50	HTX 70	HTX 100	HTX 150	HTX 180	HTX 220
art no		110.011.121	110.011.131	110.011.141	110.011.151	110.011.161	100.011.171
max. working pressure	bar/Mpa	1000 / 100	1000 / 100	1000 / 100	1000 / 100	1000 / 100	1000 / 100
stroke	mm	12	12	12	12	12	12
min. reach bolt		M36	M42	M48	M60	M72	M76
max. reach bolt		M40	M46	M56	M68	M76	M80
capacity	kN/t	501 / 51.1	702 / 71.6	999 / 101.9	1500 / 153	1803 / 183.9	2174 / 221.7
required oil content (effective)	cc	60.2	84.2	120	180	216	261
weight, ready for use	kg	3.4	4.6	6.8	10.9	14.0	20.4
dimension A	mm	119	139	166	203	220	248
dimension B	mm	60	56	65	79	85	92
dimension C	mm	102	107	120	139	150	165
dimension D	mm	55	60	70	85	90	95
dimension E	mm	96	111	125	154	174	186
dimension F	mm	83	94	112	136	148	156
dimension G	mm	67	72	82	98	103	110
dimension H	mm	45	50	60	75	80	85
dimension K	mm	8	10	10	12	12	12
dimension L	mm	20	25	30	35	40	40
dimension N	mm	15	20	20	25	25	30



PUMP

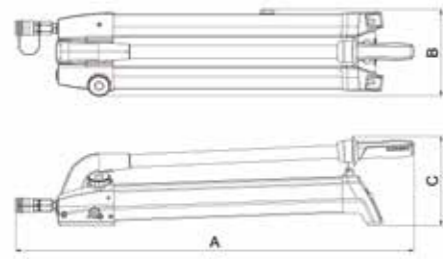

specifications		PAX 18 H 2
art no		110.142.005
max. working pressure	bar/Mpa	1000 / 100
capacity oil tank (effective)	cc	1800
capacity oil tank	cc	1990
1st stage output (per stroke)	cc	42.8
2nd stage output (per stroke)	cc	2.2
1st stage pressure range	bar/Mpa	0-45 / 0-4.5
2nd stage pressure range	bar/Mpa	45-1000 / 4.5-100
max. operating pressure	kg	34.0
connection		A 238
operator type		hand
weight, ready for use	kg	7.8
dimension A	mm	777
dimension B	mm	169
dimension C	mm	175

Features & benefits

- Ergonomic design
 - Light weight; easy to carry and operate
 - Low operating force required; minimal user effort
 - Soft-grip handles; more comfort and grip
 - Anti-slip rubber underneath; pump is stable and does not shift
 - Pump handle lock; easy and safe to carry
- Service- and maintenance-friendly; technical parts are easy to access and replace without removing the tank
- High oil output; quicker action both in the first and second stage
- Oil level glass in the tank; easily check the oil level in both horizontal and vertical position
- Integrated filler funnel; top up oil easily and quickly without extra accessories
- Push & Unlock pump handle lock; unlocking is quick and easy with one brief push on the pump handle

Hydraulic hoses	119
Couplers and accessories	120



HYDRAULIC HOSES | single hoses - 1000 bars

Features & benefits

- 4:1 safety ratio



specifications	X 1.3 M	X 3 M	X 5 M
art no	110.571.012	110.571.030	110.571.050
equipped with (connection type)	single hose	single hose	single hose
max. working pressure	bar/Mpa 1000 / 100	1000 / 100	1000 / 100
color	blue	blue	blue
hose connection A	1/4" BSP male	1/4" BSP male	1/4" BSP male
length	m 1.2	3	5

HYDRAULIC HOSES | extension hoses - 1000 bars







Features & benefits

- 4:1 safety ratio



specifications	X 1.2 MU	X 3 MU	X 5 MU
art no	110.572.012	110.572.030	110.572.050
equipped with (connection type)	single hose	single hose	single hose
max. working pressure	bar/Mpa 1000 / 100	1000 / 100	1000 / 100
color	blue	blue	blue
hose connection A	A 239	A 239	A 239
length	m 1.2	3	5

COUPLERS AND ACCESSORIES

accessories	description	model	art no
	Quick coupler, female, including aluminium dust cap <ul style="list-style-type: none"> • Connection: 1/4" BSP female • Fits: A 239 • Max. working pressure: 1000 bar 	A 238	150.581.238
	Quick coupler, female, including aluminium dust cap <ul style="list-style-type: none"> • Connection: 1/4" BSP female • Fits: A 239 • Extra lock ring • Max. working pressure: 1000 bar 	A 240	150.581.240
	Quick coupler, male, including aluminium dust cap <ul style="list-style-type: none"> • Connection: 1/4" BSP female • Fits: A 238 and A 240 • Max. working pressure: 1000 bar 	A 239	150.581.239
	2 Aluminium dust caps, 1 male and 1 female <ul style="list-style-type: none"> • Fits: A 238, A 239 and A 240 • Max. working pressure: 1000 bar 	-	150.182.010
	Pressure gauge, 0-1000 bars, including protection frame <ul style="list-style-type: none"> • Pressure gauge Ø 162 mm • Including quick coupler female, A 238 	A 148 U	110.582.348
	Coupling piece <ul style="list-style-type: none"> • Including quick coupler female, A 238 (3x) • Max. working pressure: 1000 bar 	A 240 U	110.582.240

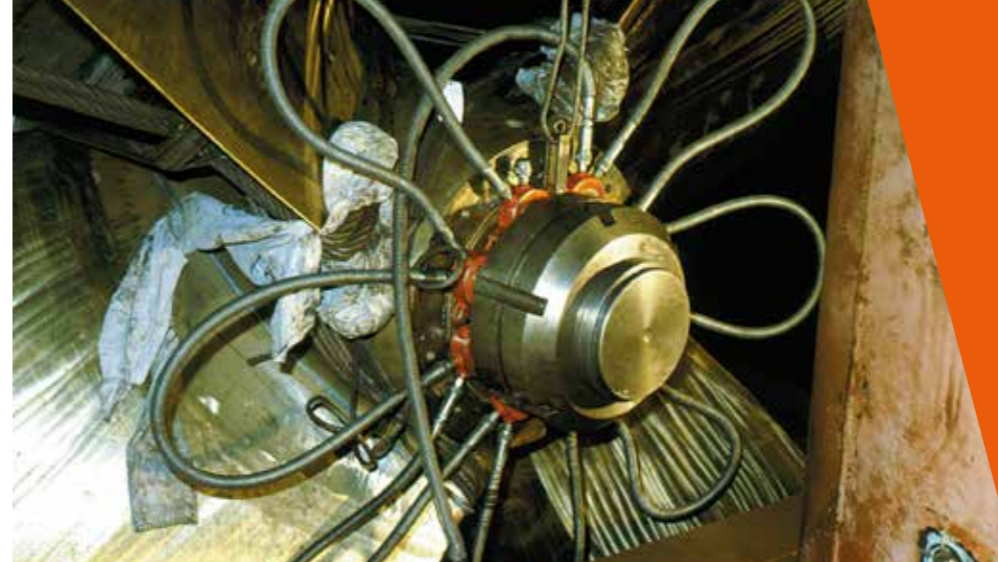
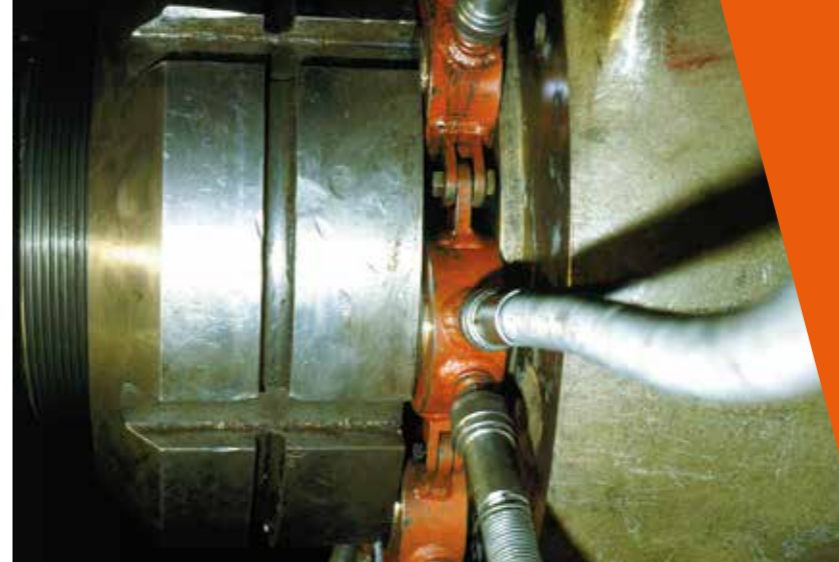

PROPELLER SET



PROPELLER CYLINDERS

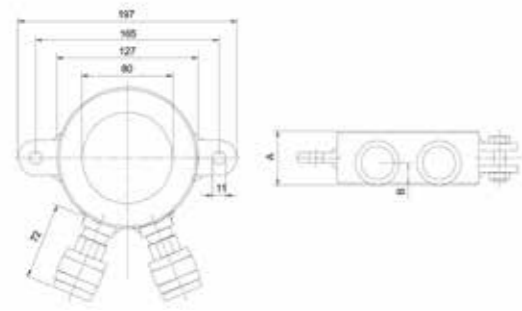

Features & benefits

- Compact
- Lightweight
- Can be adjusted to fit each propeller shaft diameter by coupling using connecting plates

Pump	124
Hydraulic hoses	125
Couplers and accessories	126

Available on request

- Cylinders manufactured in conformity with customer specifications

specifications	HY 100 G 1 U		HY 100 G 3.5 U	
art no	120.012.001		120.012.011	
max. working pressure	bar/Mpa	2000 / 200	2000 / 200	
stroke	mm	10	35	
capacity	kN/t	1000,5 / 102	100.5 / 102	
effective pressure area	cm ²	50.27	50.27	
required oil content (effective)	cc	50	176	
connection	Y 218 (2x)			
acting type	single			
return type	gravity			
material	steel			
weight, ready for use	kg	6.0	8.1	
dimension A	mm	49	85	
dimension B	mm	25	24	

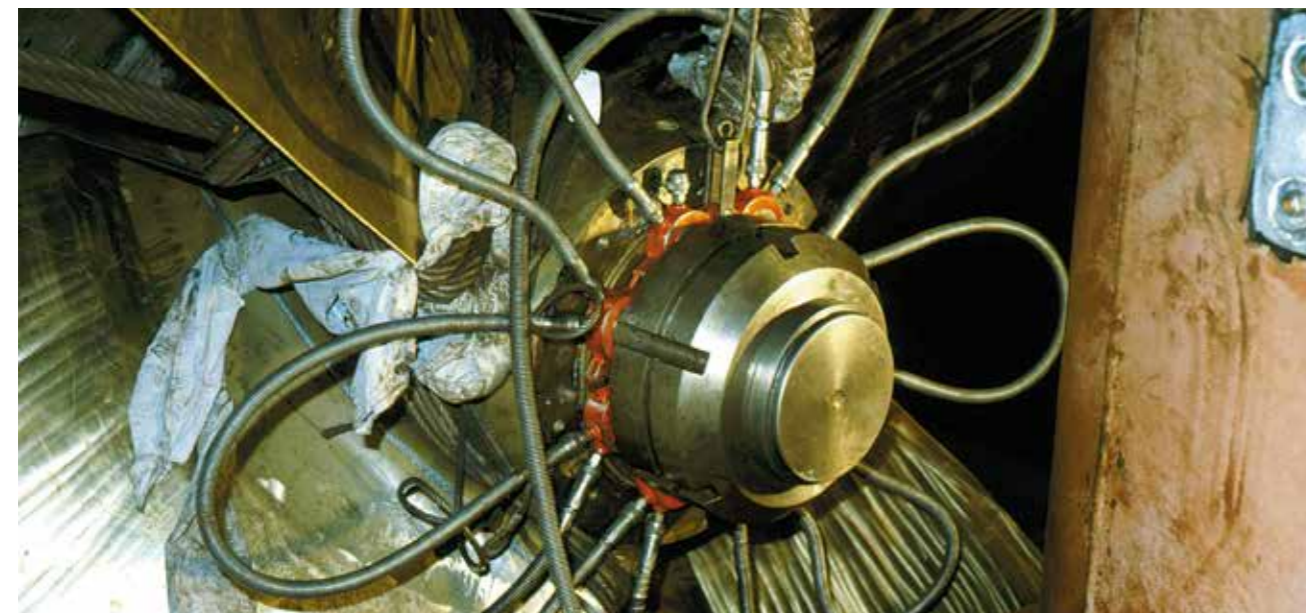

PROPELLER CYLINDERS | selection chart

Max. number of cylinders for propeller shaft

propeller shaft diameter		max. number of cylinders	max. available force	
mm	inch		ton	kN
200	8	7	700	6867
250	10	8	800	7848
300	12	9	900	8829
350	14	10	1000	9810
400	16	11	1100	10791
450	18	12	1200	11772
500	20	13	1300	12753
550	22	14	1400	13734
600	24	15	1500	14715
650	26	15	1500	14715
700	28	16	1600	15696
750	30	17	1700	16677
800	32	18	1800	17658
850	34	19	1900	18639
900	36	20	2000	19650
950	38	21	2100	20601
1000	40	22	2200	21583

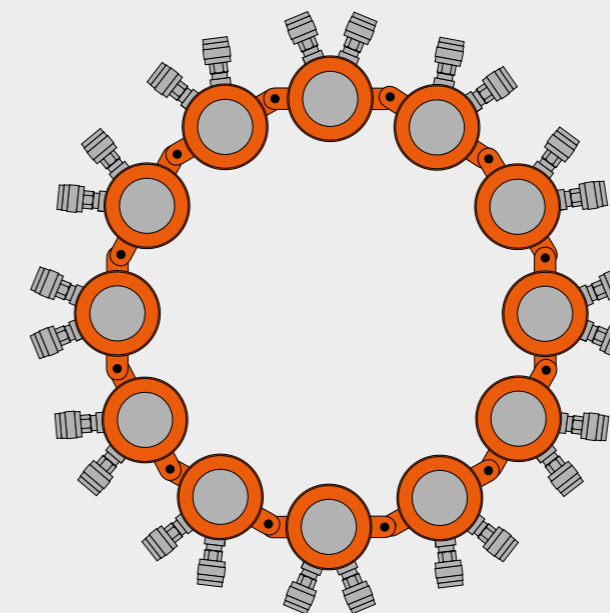
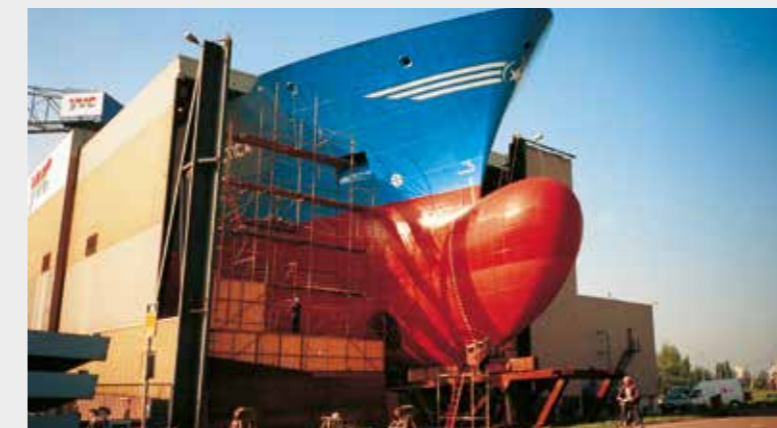

PUMP



specifications		HTWY 2300 U
art no		120.442.001
max. working pressure	bar/Mpa	2000 / 200
capacity oil tank (effective)	cc	2300
1st stage output (per stroke)	cc	31
2nd stage output (per stroke)	cc	1.6
1st stage pressure range	bar/Mpa	0-30 / 0-3
2nd stage pressure range	bar/Mpa	30-2000 / 3-200
max. operating force	kg	36.0
operator type		hand
number of tool connection		1
weight, ready for use	kg	16.0

Features & benefits

- Compact and lightweight
- Low maintenance
- Suitable for large volumes
- Automatic transition from first to second stage
- Large pump output per stroke
- Provided with dipstick

Hydraulic hoses	125
Couplers and accessories	126



HYDRAULIC HOSES | single hoses - 2000 bars

Features & benefits

- 3:1 safety ratio



specifications	Y 1.5 MK	Y 3 MK	Y 5 MK
art no	120.570.002	120.570.004	120.570.005
equipped with (connection type)	single hose	single hose	single hose
max. working pressure	bar/Mpa 2000 / 200	2000 / 200	2000 / 200
color	red	red	red
hose connection A	M26 x 1.5	M26 x 1.5	M26 x 1.5
hose connection B	M26 x 1.5	M26 x 1.5	M26 x 1.5
length	m 1.5	3	5

HYDRAULIC HOSES | extension hoses - 2000 bars







Features & benefits

- 3:1 safety ratio



specifications	Y 1.5 MKU	Y 3 MKU	Y 5 MKU
art no	120.570.003	120.570.006	120.570.007
equipped with (connection type)	single hose	single hose	single hose
max. working pressure	bar/Mpa 2000 / 200	2000 / 200	2000 / 200
color	red	red	red
hose connection A	Y 219	Y 219	Y 219
hose connection B	Y 219	Y 219	Y 219
length	m 1.5	3	5

COUPLERS AND ACCESSORIES

accessories	description	model	art no
	Coupler, female, including steel dust cap <ul style="list-style-type: none"> • Connection: M22 x 1.5 male • Fits: Y 219 • Max. working pressure: 2000 bar 	Y 218	120.481.218
	Coupler, male, including steel dust cap <ul style="list-style-type: none"> • Connection: M22 x 1.5 female • Fits: Y 218 • Max. working pressure: 2000 bar 	Y 219	120.481.219
	Nipple <ul style="list-style-type: none"> • Connection: M26 x 1.5 female - M22 x 1.5 male • For mounting Y 219 or Y 218 on loose hose • Max. working pressure: 2000 bar 	2000 bar	120.000.007
	Pressure gauge 0-2000 bar, including protection frame <ul style="list-style-type: none"> • Pressure gauge Ø 162 mm • Including coupler female, Y 218 	Y 220 U	120.182.220
	Rotation elbow <ul style="list-style-type: none"> • Including coupler male, Y 219 and coupler female Y 218 • Max. working pressure: 2000 bar 	Y 215 U	120.182.215
	Connecting plate <ul style="list-style-type: none"> • Centre to centre size: 84 mm • Max. working pressure: 2000 bar 	Y 200	120.481.200
	Suspension hook <ul style="list-style-type: none"> • Max. working pressure: 2000 bar 	Y 205	120.181.205



INDUSTRIAL SOLUTIONS

FEEL THE POWER OF COOPERATION



RERAILING SYSTEM

SYNCHRONIZED POSITIONING SYSTEM

SKIDDING SYSTEM

OFFSHORE WIND HYDRAULIC SOLUTIONS

Computer-controlled synchronized positioning of heavy loads

Features & benefits:

- Use of multiple-split-flow pumps; accurate and controlled oil flow to lifting points
- Advanced software; calculates continuously and corrects when needed
- Automatic stop; safe working
- Data logging and calibrating-function
- HMI PLC control unit with touch-screen; user-friendly control
- Pump trolley; easy relocating of the pump

Fast, accurate and safe replacing of trains on their track

Features & benefits:

- Lightweight; components are 50% lighter than similar systems
- User-friendly
- Accurate lifting and lowering; four independent control valves
- Controlled moving; sleeve bearings under the traverse sliders ensure controlled lateral movement
- Flexible; the wireless remote control makes the operator mobile
- Safe; the load is secured by special stacking rings

Horizontal movement of industrial objects and installations with exceptional sizes and weights

Features & benefits:

- Modular system; easy to adapt to different load sizes and projects
- Equal pushing and pulling capacity for controlled positioning
- Holmatro offers two modular Skidding Systems:
 - an extremely lightweight system for loads up to 200 tons
 - a system for loads up to 400 tons (assuming two skidding units are used)

Powerful systems for offshore wind

Features & benefits:

- Custom-made systems; designed for your specific job
- Capacity of 50 tons or more; powerful lightweight cylinders
- Corrosion-resistant; expanded life span

Industrial solutions

FEEL THE POWER OF COOPERATION



STEP
CYLINDER
SET



SHIP
LAUNCHING
SET



LIFTING BRIDGE
CONSTRUCTION
AT 80 M. HEIGHT



TP SEAFASTENING,
MP SKIDDING AND
UPENDING



SUBWAY
LIFTING



SUPPORTING
A CONVERTER
PLATFORM



BRIDGE
LIFTING



STRECHTING
CATERPILLAR
TRACKS

BENDING
PLATES AND
PROFILES

Larger vertical movement of heavy loads with accurate control

Features & benefits:

- Extra-large tilting saddle to prevent eccentric loads
- Step plate is made of 7075-T6 aluminium; reduces the weight of the tool
- Adjustable head; no stuffing material needed
- Flat face couplers; user-friendly and fail safe

Safe and extremely controllable sideways ship launches

Features & benefits:

- Separate oil tank and large diameter connection hose; quick and simultaneous relief
- Electrical control unit; safe and accurate control

CUSTOM MADE SOLUTIONS

Those who have challenged us already

No one knows the technical challenges of your company better than you. Every day, you experience project bottlenecks and face technical limitations. With our more than 45 years of experience, we are pleased to assist you in finding a solution to your problem. Whether it involves greater efficiency in the execution of complex projects, improving safety or excelling in extreme situations: Holmatro provides the right solution.

On our website you will find a selection of our customer projects. Allow us to inspire you with the selection and challenge us to come up with a solution for your specific problem.

www.holmatro.com

INDUSTRIAL SOLUTIONS CATALOGUE?

Call **+31 (0)162-751500**
or send an e-mail to
industry@holmatro.com



HOLMATRO SERVICE PROGRAMME

A total solution

Applicable to all brands of hydraulic equipment is that malfunctions and defects will occasionally occur over time. Regular maintenance and correct usage are of great importance in ensuring that your equipment can continue to be employed optimally and safely during its entire operating life span.

Holmatro can help you here. As a manufacturer of hydraulic equipment we are the ideal service specialist in the field. We know, how important professional maintenance is; not only for optimal functioning of the equipment, but also for the safety of the people who use it.

This is why Holmatro offers a comprehensive service programme for the following hydraulic tools from 500 to 4,000 bar:

- Industrial tools (cylinders, pumps and system components)
- Hydraulic cutters and spreaders
- Additionally we also provide a service programme for hydraulic foundry tools.

The Holmatro service programme consists of the following services:

- Periodic maintenance
- Repairs
- Testing and certification
- Training and advice

SCC*
ISO 9001
BUREAU VERITAS
Certification



WE WILL BE HAPPY TO HELP YOU DRAW UP A CUSTOMIZED SERVICE SOLUTION



holmatro
testteam

Holmatro testteam

At Holmatro we combine high pressure hydraulics with innovative design and material use. The result is powerful, lightweight tools. Hydraulics is a form of drive technology. Power and movement is transferred and controlled using pressurised oil.

The Holmatro Testteam gives an animated look at the possibilities and results of working with high pressure hydraulics. Let Holmatro's service engineers surprise you and watch the films on our website!



HOLMATRO OFFICES AND DEALERS

All over the world

Thanks to our worldwide sales and service network there's always a Holmatro representative nearby, ready to assist you!

Find your nearest Holmatro representative on holmatro.com



Holmatro Netherlands

Raamsdonksveer,
The Netherlands
T +31 (0) 162 75 15 00
E industry@holmatro.com

Holmatro USA

Glen Burnie MD,
USA
T +1 (0) 410-768-9662
E industrial@holmatro-usa.com

Holmatro China

Suzhou, Jiangsu Province
China
T +86 (512) 6380 7060
E china@holmatro.com



Disclaimer - While the greatest care has been devoted to the content, it is possible that the information in this printed matter is incorrect or incomplete. N.V. Holmatro and its affiliated companies (here-after: Holmatro) cannot be held liable in any way for the consequences of activities undertaken based on this printed matter. If you have any doubts about the correctness or completeness of the information, you shall contact Holmatro (phone number: +31 (0)162-751500. Nothing from this printed matter can be copied and/or made public in any way without the explicit authorization of Holmatro.

FEEL THE POWER

holmatro.com



Powered by Holmatro



@ByHolmatro



Holmatro Industrial Equipment



Holmatro Industry