

General information

PVS5620211210

The DAT 400 weight transmitter is an exclusive product of Pavone Sistemi that guarantees high performance and reliability. It has an upload and download function for programming with Tester 1008. Configuration and calibration can be set up from the front panel or from a PC via the USB port. The bipolar option is available on request. The DAT 400 weight transmitter can be customized according to customer needs. It has a peak hold function for dynamic measures and screw terminal blocks.

Software Innovation 2: [innovation_2_weighing_software.zip](#)Technical Manual: [dat-400_en.pdf](#)Technical Manual: [dat-400_analog_en.pdf](#)

All indicated data may be changed without notice.
All the measures indicated are expressed in millimeters (mm).

Technical specifications

PVS5620211210

Measuring range:	-0.5 ÷ +3.5 mV/V (-3.9 ÷ +3.9 mV/V optional)
Input sensitivity:	0.02 µV/count
Full scale non-Linearity:	< 0.01%
Gain drift:	< 0.001% FS/°C
Display:	6 digit, red LED (7 segments), h 14 mm
A/D Converter:	24 bit
Internal Resolution:	> 16.000.000 points
Transducer input voltage:	5 V (max 6 load cells 350 Ohm)
Visible resolution (in divisions):	60000
Divisions value (adjustable):	x1, x2, x5
Decimal figures range:	0 ÷ 3
Temperature range:	-10 ÷ +50°C (max umidity 85% without condensation)
Storage temperature:	-20 ÷ +70 °C
Filter:	0.1 ÷ 25 Hz
Logic output:	2 Solid-state relays, (maximum load 24 Vdc / 100 mA each)
Logic input:	2 optoisolated 24 Vdc PNP (External voltage)
Serial port:	Nr. 2 - USB/RS232C, RS422/485 with ASCII or Modbus RTU protocols
Power supply:	24 Vcc ±15% - power 5 W
Regulatory compliance:	EN61326-1, EN55011, EN55014 for EMC; EN61010-1 for electrical security
Dimensions and weight:	106 x 90 x 58 mm (L x H x P); 250 g
Baud rate:	2400, 9600, 19200, 38400, 115200 adjustable (RS232)
Transmission distance:	15m (RS232C), 1000m (RS422; RS485)

All indicated data may be changed without notice.
 All the measures indicated are expressed in millimeters (mm).

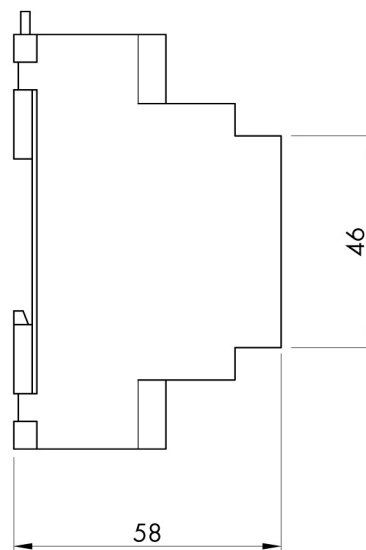
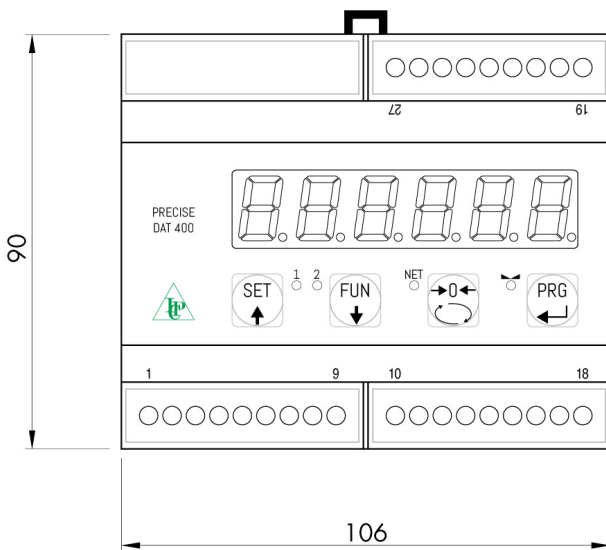
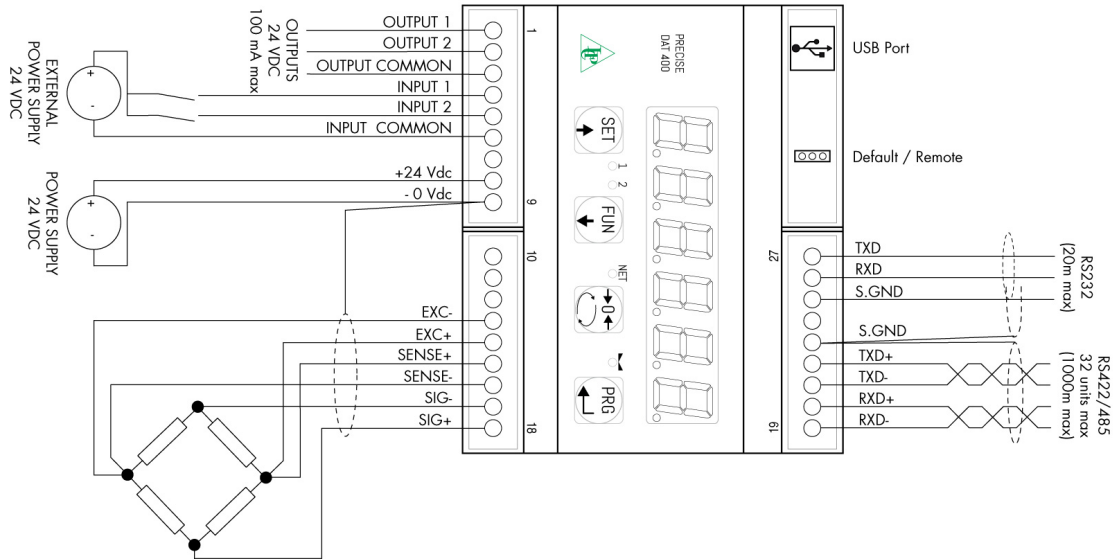

All indicated data may be changed without notice.
 All the measures indicated are expressed in millimeters (mm).